



FEATURES

- Outputs: 4 x channels
- BUS+SEQUENCER+FADER+DIMMER+DRIVER
- Input: DC 12/24/48 Vdc
- BUS Command: DMX512+RDM, DALI, MODBUS
- LOCAL Command: 4x N.O. push button (with or without memory), 0-10V, 1-10V
- Controls: dimmer, dim to warm, tunable white, RGB, RGBW
- Voltage outputs for R-L-C loads
- Typical efficiency > 95%
- Adjusting the brightness up to completed off (Dim to dark)
- Level minimum of brightness: 0.1% (1% in push)
- D-PWM Modulation
- Adjusting D-PWM frequency: 300 / 600 / 1200 Hz
- Adjusting output curve: Linear / Quadratic / Exponential
- Soft start and soft stop
- Soft dimming regulation
- Master / Slave Function (DMX variant)
- Extended temperature range
- 100% Functional test – 5 Years warranty

→ For the whole and updated Device Manual refer to producer's website: <http://www.dalcnet.com>

Constant voltage variants (common anode)

- Application (4-channels output): Dimmer, Dim to warm, Tunable White, RGB, RGBW

CODE	Supply Voltage	Output	Channels	Command	
DLD1248-4CV-DMX	12/24/48V DC	1x20A max 4x5A max	4	DMX N.O. push button / 0-10 / 1-10	PROFESSIONAL
DLD1248-4CV-MODBUS	12/24/48V DC	1x20A max 4x5A max	4	MODBUS RTU N.O. push button / 0-10 / 1-10	PROFESSIONAL
DLD1248-4CV-DALI	12/24/48V DC	1x20A max 4x5A max	4	DALI N.O. push button / 0-10 / 1-10	PROFESSIONAL

Protections

OTP	Over temperature protection
OVP	Over voltage protection
UVP	Under voltage protection
RVP	Reverse polarity protection
IFP	Input fuse protection
SCP	Short circuit protection
OCP	Open circuit protection
CLP	Current limit protection



Reference Standards

EN 61347-1	Lamp controlgear - Part 1: General and safety requirements
EN 62384	DC or AC supplied electronic control gear for LED modules - Performance requirements
EN 55015	Limits and methods of measurement of radio disturbance characteristics of electrical lighting and similar equipment
EN 61547	Equipment for general lighting purposes - EMC immunity requirements
EN 50581	Technical documentation for the assessment of electrical and electronic products with respect to the restriction of hazardous substances
IEC/EN 62386-101	Digital addressable lighting interface - Part 101: General requirements - System
IEC/EN 62386-102	Digital addressable lighting interface - Part 102: General requirements - Control gear
IEC/EN 62386-207	Digital addressable lighting interface - Part 207: Particular requirements for control gear - LED modules (device type 6)
IEC 60929-E.2.1	Control interface for controllable ballasts - control by d.c. voltage - functional specification
ANSI E 1.3	Entertainment Technology - Lighting Control Systems - 0 to 10V Analog Control Specification
ANSI E1.11	Entertainment Technology - USITT DMX512-A - Asynchronous Serial Digital Data Transmission Standard for Controlling Lighting Equipment and Accessories
ANSI E1.20	Entertainment Technology-RDM-Remote Device Management over USITT DMX512 Networks
-	MODBUS APPLICATION PROTOCOL SPECIFICATION V1.1b

Technical Specification

		Variants
		Constant voltage
Supply voltage		DC min: 10,8 Vdc .. max: 52,8 Vdc
Output voltage		= Vin
Output current		max 20A 4x max 5 A ³⁾ // max 20 A ³⁾
Nominal power ³⁾	@12V	240 W
	@24V	480 W
	@48V	960 W
Thermal shutdown		150 °C
D-PWM dimming frequency		300Hz – 600Hz – 1200Hz
D-PWM resolution		16 bit
D-PWM range		0,1% ÷ 100%
Storage Temperature		min: -40 max: +60 °C
Ambient Temperature ³⁾		min: -40 max: +60 °C
Protection grade		IP10
Wiring		Buttons & Bus: 1.5 mm ² solid - 1 mm ² stranded - 30/14 AWG Power & Leds: 2.5mm ² solid - 1.5mm ² stranded - 30/12 AWG
Mechanical dimensions		72 x 92 x 62 mm - DIN RAIL 4mod.
Packaging dimensions		124 x 85 x 71 mm
Weight		125g

³⁾ maximum value, dependent on the ventilation conditions

• **Installation**

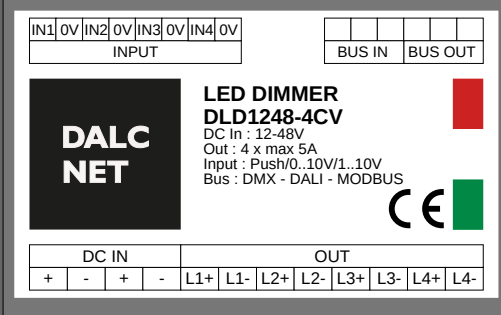
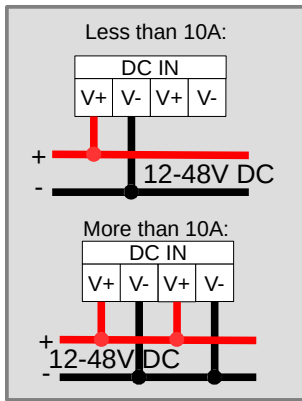
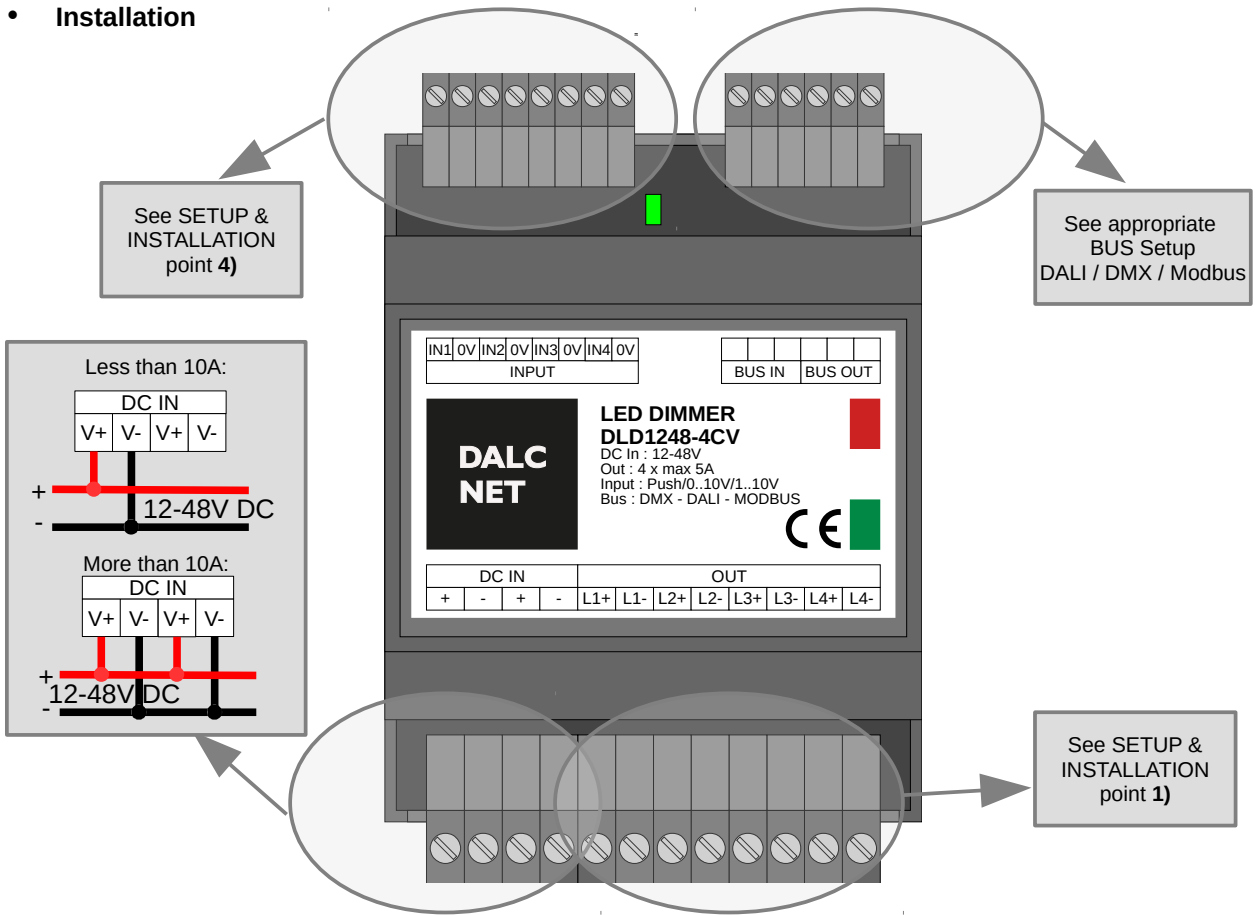

Mechanical dimension:
 (without connectors)

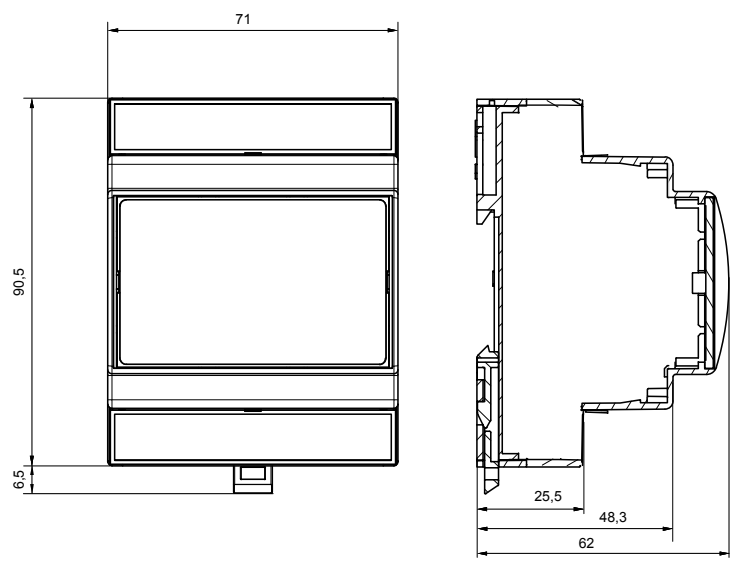

Opening the cover

For the Dip-switch and selectors configuration it is necessary to pull up the cover of the device. See the picture.

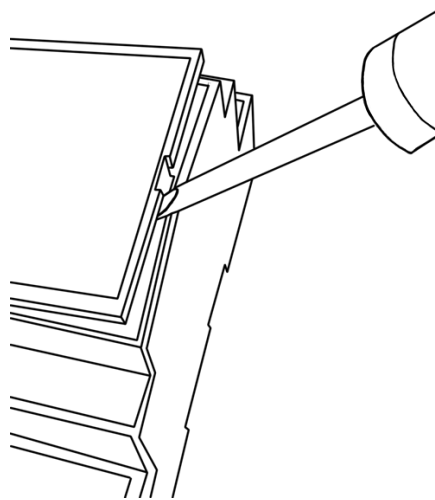

Technical notes

- Installation and maintenance must be performed only by qualified personnel in compliance with current regulations.
- The product must be installed inside an electrical panel protected against overvoltages.
- The product must be installed in a vertical or horizontal position with the cover / label upwards or vertically; other positions are not permitted. It is not permitted the bottom-up position (with the lower face plate / label).
- Keep separate the 230V circuits (LV) and not SELV circuits from safety extra low voltage (SELV) and all connections for this product. It's absolutely forbidden to connect, for any reason, directly or indirectly, the 230V mains voltage to the bus or to other parts of the circuit.
- For power supply use only SELV power supplies with limited current and short circuit protection, and of appropriately sized power. In case of power supplies provided with an earth terminal, ALL protective earthing points (PE = Protection Earth) must be connected to a valid protection earth.
- The connection cables between the power source and the product must be sized properly and should be isolated from any wiring or live parts not SELV. Use double insulated cables.
- In the event of higher than 10A total output current to plug into both power input pairs "V +" and "V-".
- Dimension the power supply for the load connected to the device. If the power supply is oversized compared to the maximum running current, insert a protection against over-current between the power supply and the device.
- For the constant current outputs, the maximum voltage drop of the LED module (V_f) must be less than the supply voltage of at least 5V.
- The length of the connecting cables between the local controls (push button, 0-10V, 1-10V, potentiometer, or other) and the product must be less than 10m; the cables must be sized properly and should be isolated from any wiring or live parts not SELV. Use double insulation shielded and twisted cables.
- The length and type of the connection cables at the BUS (DMX512, Modbus, DALI, Ethernet, or other) use cables as per specification of the respective protocols and regulations and they should be isolated from every wiring or parts at voltage not SELV. It is suggested to use double insulated shielded and twisted cables.
- All devices and related control signals to the bus (DMX512, Modbus, DALI, Ethernet or other) and to the local controls (push button, 0-10V, 1-10V, potentiometer, or other) must be SELV (connected devices must be SELV or otherwise provide a SELV signal).
- The length of the connection cables between the product and the LED module must be dimensioned correctly and they should be isolated from every wiring or parts at voltage not SELV. It is suggested to use double insulated shielded and twisted cables.











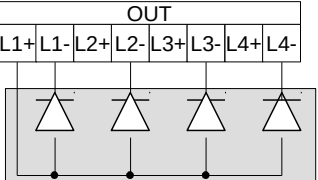
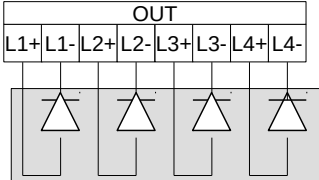

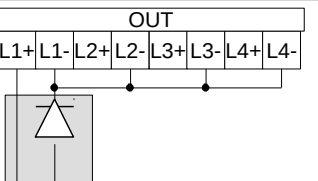
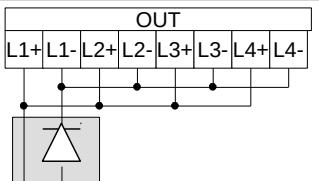
■ SETUP & INSTALLATION

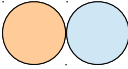
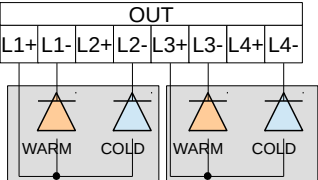
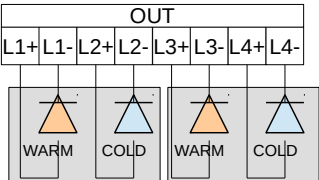
A 12 way dip-switch (under the cover) can provide a rich set of possible configurations:

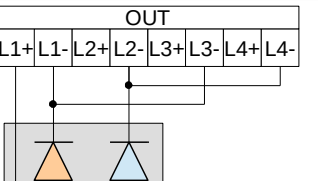
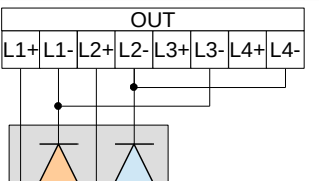
Note: Factory positions = all OFF

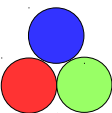
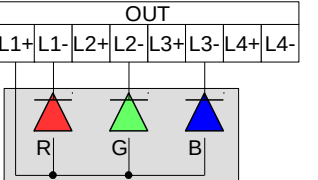
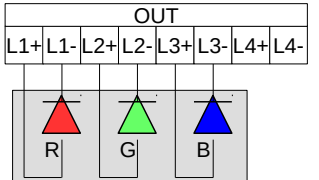

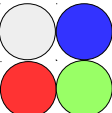
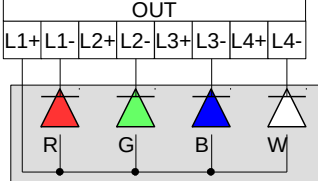
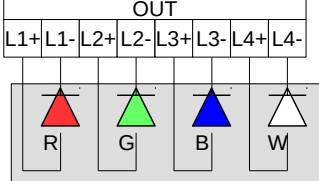





















Function		<ul style="list-style-type: none"> • Switches from 1 to 2: Load Type • Switch 3: Parallel Outputs • Switches from 4 to 6: Map • Switches from 7 to 8: Curve • Switches from 9 to 10: Input Type • Switches from 11 to 12: Output frame rate (freq.) 																								
	<table border="1"> <tr> <td>1</td><td>2</td><td>3</td><td>4</td><td>5</td><td>6</td><td>7</td><td>8</td><td>9</td><td>10</td><td>11</td><td>12</td> </tr> <tr> <td>Load</td><td>//</td><td>Map</td><td>Curve</td><td>Input</td><td>Hz</td><td></td><td></td><td></td><td></td><td></td><td></td> </tr> </table>	1	2	3	4	5	6	7	8	9	10	11	12	Load	//	Map	Curve	Input	Hz							
1	2	3	4	5	6	7	8	9	10	11	12															
Load	//	Map	Curve	Input	Hz																					

1) Select Load Type and Parallel Out depending on output connections: Switches from 1 to 2 and Switch 3





Load Type	Description	Connections (total current 0 - 10A max)	Connections (total current 0 - 20A max)	Settings
	White, up to 4 loads			
	White, parallel outputs with increased current (Macro dimmer)			
	Tunable White, up to 2 loads			
	Tunable White, parallel output pairs with increased current			
	RGB			
	RGBW			

Note: Set the "Select Map" according to the connected load and the function you want. See "Map Setting" page 6.







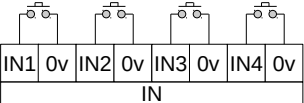

2) Select Map: Switches from 4 to 6

White Load	Tunable White Load	RGB Load	RGBW Load
			
Dimmer 	Dimmer 	Dimmer 	Dimmer 
	Dim to Warm 	Dim to Warm 	Dim to Warm 
	Tunable White 	Tunable White 	Tunable White 
		Smart HSV Intensity, temperature correction, color hue & rotation, saturation and strobe 	Smart HSV Intensity, temperature correction, color hue & rotation, saturation and strobe 
		RGB 	RGB Convert RGB → RGBW 
		RGBW Convert RGBW → RGB 	RGBW 
		Master+RGB+Strobe 	Master+RGB+Strobe Convert RGB → RGBW 
		Master+RGBW+Strobe Convert RGBW → RGB 	Master+RGBW+Strobe 

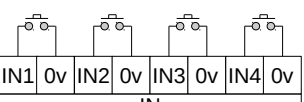
3) Select Dimming Curve: Switches from 7 to 8

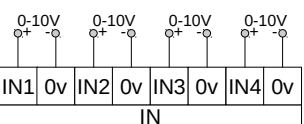
Default (by bus type) 	Exponential 	Quadratic 	Linear 
---	---	---	--

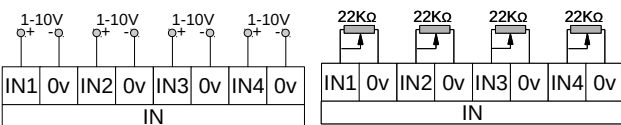



































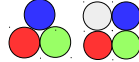

















4) Select Local Input Type: Switches from 9 to 10

In Type	Description	Connections	Settings
Push	N.O. Pushbutton, NO memory		
	N.O. Pushbutton, MEMORY		
0-10V	Analogic 0-10V		
1-10V	Analogic 1-10V & Potentiometer		

5) Set Output Frequency: Switches from 11 to 12

300Hz 	600Hz 	1200Hz 	Reserved 
---	---	--	--

■ Local commands functionality according to the selected Map

Load Type	Map	IN 1	IN 2	IN 3	IN 4
 White up to 4 loads	Dimmer	Dim1 	Dim2 	Dim3 	Dim4 
 White Parallel outs	Dimmer	Dimmer 			
 Tunable White up to 2 loads	Dimmer	Dim1 		Dim2 	
 Tunable White Parallel outs	Dimmer	Dimmer 			
 Tunable White up to 2 loads	Dim to Warm	Dim1 to Warm 		Dim2 to Warm 	
 Tunable White Parallel outs	Dim to Warm	Dimmer to Warm 			
 Tunable White up to 2 loads	Tunable White	Dim1 	CCT1 	Dim2 	CCT2 
 Tunable White Parallel outs	Tunable White	Dimmer 	CCT 		
 RGB & RGBW	Dimmer	Dimmer 			
 RGB & RGBW	Dim to Warm	Dimmer to Warm 			
 RGB & RGBW	Tunable White	Dimmer 	CCT 		
 RGB & RGBW	Smart HSV	Dimmer 	CCT 	Color 	Saturation 
 RGB & RGBW	RGB	Red 	Green 	Blue 	
 RGB & RGBW	RGBW	Red 	Green 	Blue 	White 
 RGB & RGBW	MRGB+	Red 	Green 	Blue 	
 RGB & RGBW	MRGBW+	Red 	Green 	Blue 	White 

■ **LOCAL INPUTS**

Available Functions: N.O. PUSH BUTTON memory / N.O. PUSH BUTTON no memory:



Dimmer

Dim the light following the selected dimming curve, keeping a constant color temperature.
 Soft Turn On with 200ms fade time, Soft Turn Off with 1s fade time.

CLICK: Turn ON/OFF light.
 Double Click: Turn On light at 100%
 Long pressure (>1s) from OFF: Turn on at 1% (Nighttime)
 Long pressure (>1s) from ON: Dimmer UP/DOWN



Dim to Warm

Dim the light following the selected dimming curve. The color temperature increase with intensity.
 Soft Turn On with 200ms fade time, Soft Turn Off with 1s fade time.

CLICK: Turn ON/OFF light.
 Double Click: Turn On light at 100%
 Long pressure (>1s) from OFF: Turn on at 1% (Nighttime)
 Long pressure (>1s) from ON: Dimmer UP/DOWN

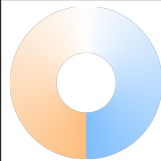

CCT: Color Correction Temperature / White Balance

- Tunable White load: change the color temperature, keeping a constant intensity. Neutral white is 50% cold + 50% warm.
 - RGB load: change the equivalent color temperature. Neutral white is an equal value to R,G,B.
 - RGBW load: balance the white from the white output to the composite RGB output. Neutral white is 50% white + 50% R+G+B.

Double Click: Neutral white
 Long pressure (>1s): Change Colour Temperature UP/DOWN (Cold ↔ Warm or White ↔ R+G+B).



Color rotation and selection

Change the color or color rotation speed.

CLICK: Start/stop color rotation.
 Double Click: Change from color (or color rotation) to white and vice-versa.
 Long pressure (>1s) from ON: Change the rotation speed, selected from 4 predefined levels.
 The selected speed is visualized as a white strobo light.

Rotation Speed	Strobo Pulse
6 seconds	10 flashes/sec.
30 seconds	5 flashes/sec.
6 minutes	2 flashes/sec.
30 minutes	1 flash/sec.

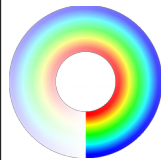

Color saturation:

Change the color saturation: vivid colors ↔ pastel colors

CLICK: Toggle between white and colors.
 Double Click: Maximum saturation - Vivid Colors.
 Long pressure (>1s) from white: Minimum saturation - Pastel Colors.
 Long pressure (>1s) from color: Change the saturation value..



Red: linear change red channel.

CLICK: Turn ON/OFF channel.
 Double Click: Turn On channel at 100%
 Long pressure (>1s) from OFF: Turn on at 1%
 Long pressure (>1s) from ON: Dim UP/DOWN



Green: linear change green channel.

CLICK: Turn ON/OFF channel.
 Double Click: Turn On channel at 100%
 Long pressure (>1s) from OFF: Turn on at 1%
 Long pressure (>1s) from ON: Dim UP/DOWN

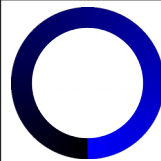

Blue: linear change blue channel.



CLICK: Turn ON/OFF channel.
 Double Click: Turn On channel at 100%
 Long pressure (>1s) from OFF: Turn on at 1%
 Long pressure (>1s) from ON: Dim UP/DOWN



White: linear change white channel.

CLICK: Turn ON/OFF channel.
 Double Click: Turn On channel at 100%
 Long pressure (>1s) from OFF: Turn on at 1%
 Long pressure (>1s) from ON: Dim UP/DOWN

Available Functions: 0-10V / 1-10V / potentiometers:

	Dimmer Dim the light following the selected dimming curve, keeping a constant color temperature. Minimum intensity = 0.1%. Below 1V = Turn OFF light. 10V = Maximum intensity.
	Dim to Warm Dim the light following the selected dimming curve. The color temperature increase with intensity. Minimum intensity = 0.1%. Below 1V = Turn OFF light. 10V = Maximum intensity.
	CCT: Color Correction Temperature / White Balance -Tunable White load: change the color temperature, keeping a constant intensity. Neutral white is 50% cold + 50% warm. - RGB load: change the equivalent color temperature. Neutral white is an equal value to R,G,B. - RGBW load: balance the white from the white output to the composite RGB output. Neutral white is 50% white + 50% R+G+B. Change the color temperature from warm (1V), to cold (10V).
	Color rotation and selection Change the color. Select a color starting from red (1V), then yellow, green, cyan, blue, magenta and red again (10V).
	Color saturation: Change the color saturation: vivid colors ↔ pastel colors Change the saturation from white (1V), to vivid colors (10V).
	Red: linear change red channel. Below 1V = Turn OFF channel. 10V = Maximum intensity.
	Green: linear change green channel. Below 1V = Turn OFF channel. 10V = Maximum intensity.
	Blue: linear change blue channel. Below 1V = Turn OFF channel. 10V = Maximum intensity.
	White: linear change white channel. Below 1V = Turn OFF channel. 10V = Maximum intensity.

■ DALI BUS SETUP

In **DALI BUS SETUP** all the leds are controlled by an external DALI controller.

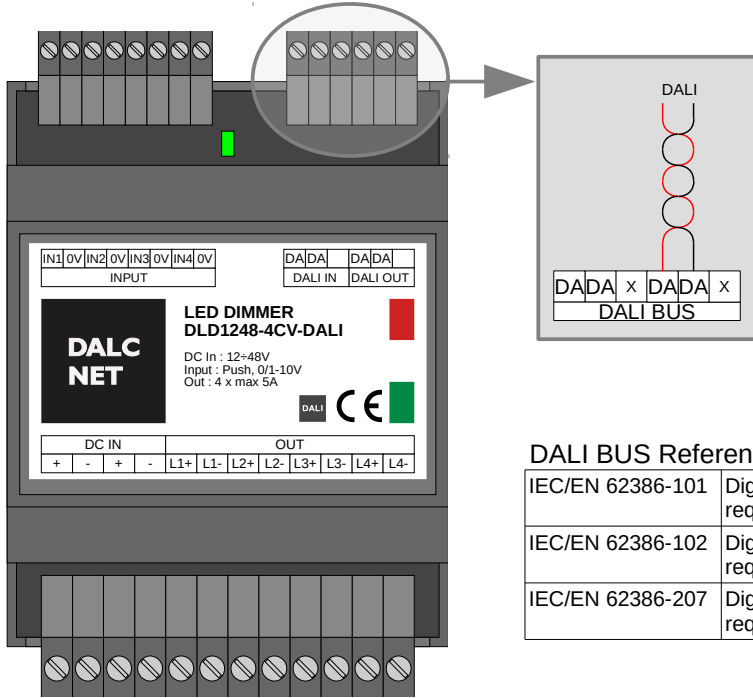

DALI BUS Reference Standards

IEC/EN 62386-101	Digital addressable lighting interface - Part 101: General requirements - System
IEC/EN 62386-102	Digital addressable lighting interface - Part 102: General requirements - Control gear
IEC/EN 62386-207	Digital addressable lighting interface - Part 207: Particular requirements for control gear - LED modules (device type 6)

Onboard led:



- In the case of no bus power detected, or bus error, the led blinks fast (2 pulsed per second).
- In the case of bus power but no data, led blinks slow (1 pulse per second).
- In the case of data link active, the led stands on.

Relation with local commands

- At power-up, in case of absence of connection to the BUS, local control is active.
- When the BUS is detected, the control passes to the BUS. It remains to the BUS until there is signal.
- In the absence of signal:
 - if the local command is N.O. PUSH BUTTON, the control passes to local command in the event of a N.O. push button pressure.
 - if the local command is 0-10V or 1-10V the control passes immediately to the local command.

Addressing

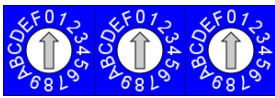
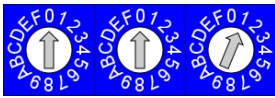
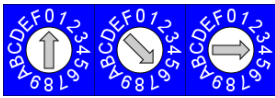
By selectors	✓
Simplified method (One ballast connected at a time)	✓
Random Address Allocation	✓

DALI	000 (default):		Address defined by DALI
	from 001	 to 	First channel address, form 1 to 64
	FFF		(reserved)

CHANNELS MAP – DALI

Load Type: White - up to 4 loads

Addr	Function	Map: Dimmer	
+0	Dimmer 1		Dimmer (Brightness Value) 0 .. 254
+1	Dimmer 2		Dimmer (Brightness Value) 0 .. 254
+2	Dimmer 3		Dimmer (Brightness Value) 0 .. 254
+3	Dimmer 4		Dimmer (Brightness Value) 0 .. 254

Load Type: White - Parallel outs (Macro dimmer)

Addr	Function	Map: Dimmer	
+0	Dimmer		Dimmer (Brightness Value) 0 .. 254

Load Type: Tunable White – up to 2 loads

Addr	Function	Map: Dimmer	
+0	Dimmer 1		Dimmer (Brightness Value) 0 .. 254
+1	Dimmer 2		Dimmer (Brightness Value) 0 .. 254

Addr	Function	Map: Dim to Warm	
+0	Dimmer 1		Dimmer (Brightness Value) 0 .. 254
+1	Dimmer 2		Dimmer (Brightness Value) 0 .. 254

Addr	Function	Map: Tunable white	
+0	Dimmer 1		Dimmer (Brightness Value) 0 .. 254
+1	Color Correction 1		Color Correction Temperature 0 .. 254
+2	Dimmer 2		Dimmer (Brightness Value) 0 .. 254
+3	Color Correction 2		Color Correction Temperature 0 .. 254

Load Type: Tunable White – Parallel outs

Addr	Function	Map: Dimmer	
+0	Dimmer 1		Dimmer (Brightness Value) 0 .. 254

Addr	Function	Map: Dim to Warm	
+0	Dimmer		Dimmer (Brightness Value) 0 .. 254

Addr	Function	Map: Tunable white	
+0	Dimmer		Dimmer (Brightness Value) 0 .. 254
+1	Color Correction		Color Correction Temperature 0 .. 254

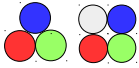

Load Type: RGB & RGBW

Addr	Function	Map: Dimmer
+0	Master Dimmer	Dimmer (Brightness Value) 0 .. 254

Addr	Function	Map: Dim to Warm
+0	Master Dimmer	Dimmer (Brightness Value) 0 .. 254

Addr	Function	Map: Tunable white
+0	Master Dimmer	Dimmer (Brightness Value) 0 .. 254
+1	Color Correction	Color Temperature Correction 0 .. 254

Addr	Function	Smart HSV
+0	Master Dimmer	Master Dimmer (Brightness Value) 0 .. 254
+1	Color Correction	Color Temperature Correction 0 .. 254
+2	Hue	Hue 0 .. 254
+3	Hue Rotation (rainbow) Time	Hue Fine 0 .. 15 Hold 16 .. 25 30min 26 .. 51 15min 52 .. 76 6min 77 .. 102 3min 103..127 1min 128..153 30s 154..179 15s 180..204 6s 205..230 3s 231..254
+4	Saturation	Saturation 0 .. 254
+5	Strobo Rate	fix 0 .. 15 blackout 16 .. 31 1fps 32 .. 47 2fps 48 .. 63 3fps 64 .. 79 4fps 80 .. 95 5fps 96 .. 111 6fps 112..127 7fps 128..143 8fps 144..159 9fps 160..175 10fps 176..191 12fps 192..207 14fps 208..223 16fps 224..239 fix 240..254

Addr	Function	Map: RGB
+0	R	R 0 .. 254
+1	G	G 0 .. 254
+2	B	B 0 .. 254

Addr	Function	Map: RGBW
+0	R	R 0 .. 254
+1	G	G 0 .. 254
+2	B	B 0 .. 254
+3	W	W 0 .. 254

Addr	Function	Map: MRGB+
+0	Master Dimmer	Master Dimmer (Brightness Value) 0 .. 254
+1	R	R 0 .. 254
+2	G	G 0 .. 254
+3	B	B 0 .. 254
+4	Strobo Rate	fix blackout 1fps 2fps 3fps 4fps 5fps 6fps 7fps 8fps 9fps 10fps 12fps 14fps 16fps fix

Addr	Function	Map: MRGBW+
+0	Master Dimmer	Master Dimmer (Brightness Value) 0 .. 254
+1	R	R 0 .. 254
+2	G	G 0 .. 254
+3	B	B 0 .. 254
+4	W	W 0 .. 254
+5	Strobo Rate	fix blackout 1fps 2fps 3fps 4fps 5fps 6fps 7fps 8fps 9fps 10fps 12fps 14fps 16fps fix

■ **DMX+RDM BUS SETUP**

With the **DMX+RDM BUS SETUP** in the “slave” condition the outputs are managed by an external DMX controller.

In the “master” condition, the DMX+RDM allows the communications between devices.

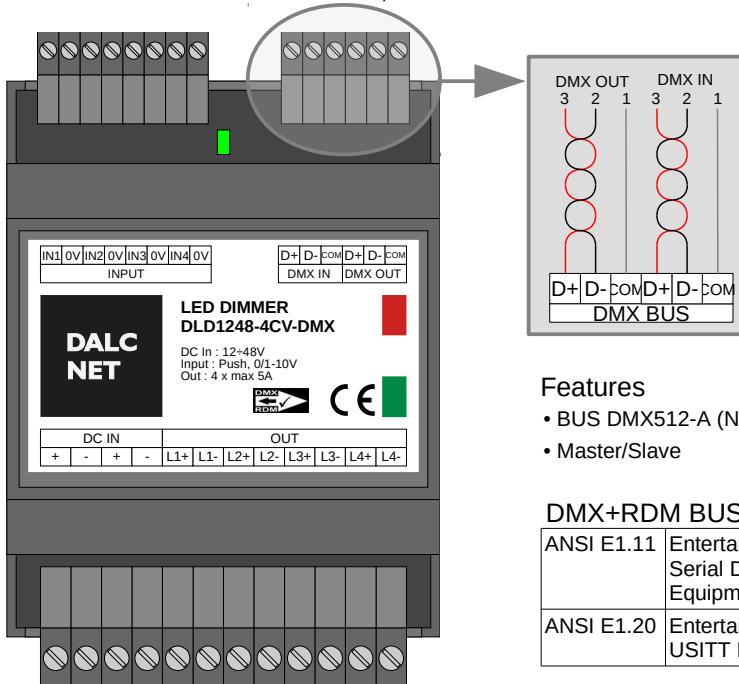

Features

- BUS DMX512-A (NSC+RDM)
- Master/Slave

DMX+RDM BUS Reference Standards

ANSI E1.11	Entertainment Technology - USITT DMX512-A - Asynchronous Serial Digital Data Transmission Standard for Controlling Lighting Equipment and Accessories
ANSI E1.20	Entertainment Technology-RDM-Remote Device Management over USITT DMX512 Networks

Onboard led:

- In the case of bus error, the led blinks fast (2 pulsed per second).
- In the case of no bus detected, led blinks slow (1 pulse per second).
- In the case of data link active, the led stands on.

Relation with local commands

- At power-up, in case of absence of connection to the BUS, local control is active.
- When the BUS is detected, the control passes to the BUS. It remains to the BUS until there is signal.
- In the absence of signal:
 - if the local command is N.O. PUSH BUTTON, the control passes to local command in the event of a N.O. push button pressure.
 - if the local command is 0-10V or 1-10V the control passes immediately to the local command.

Addressing

RDM	<input checked="" type="checkbox"/>
By selectors	<input checked="" type="checkbox"/>

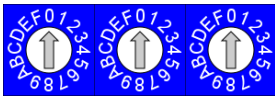
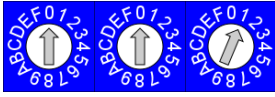
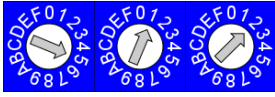
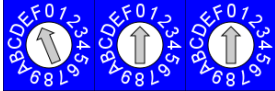
DMX	000 (default):		Address defined by RDM
	from 001	 to 	First channel address, from 1 to 512
	F00		MASTER

CHANNELS MAP – DMX512

Load Type: White - up to 4 loads

Ch.	Function	Map: Dimmer
1	Dimmer 1	Dimmer (Brightness Value) 0 .. 255
2	Dimmer 2	Dimmer (Brightness Value) 0 .. 255
3	Dimmer 3	Dimmer (Brightness Value) 0 .. 255
4	Dimmer 4	Dimmer (Brightness Value) 0 .. 255

Load Type: White - Parallel outs (Macro dimmer)

Ch.	Function	Map: Dimmer
1	Dimmer	Dimmer (Brightness Value) 0 .. 255

Load Type: Tunable White – up to 2 loads

Ch.	Function	Map: Dimmer
1	Dimmer 1	Dimmer (Brightness Value) 0 .. 255
2	Dimmer 2	Dimmer (Brightness Value) 0 .. 255

Ch.	Function	Map: Dim to Warm
1	Dimmer 1	Dimmer (Brightness Value) 0 .. 255
2	Dimmer 2	Dimmer (Brightness Value) 0 .. 255

Ch.	Function	Map: Tunable white
1	Dimmer 1	Dimmer (Brightness Value) 0 .. 255
2	Color Correction 1	Color Correction Temperature 0 .. 255
3	Dimmer 2	Dimmer (Brightness Value) 0 .. 255
4	Color Correction 2	Color Correction Temperature 0 .. 255

Load Type: Tunable White – Parallel outs

Ch.	Function	Map: Dimmer
1	Dimmer 1	Dimmer (Brightness Value) 0 .. 255

Ch.	Function	Map: Dim to Warm
1	Dimmer	Dimmer (Brightness Value) 0 .. 255

Ch.	Function	Map: Tunable white
1	Dimmer	Dimmer (Brightness Value) 0 .. 255
2	Color Correction	Color Correction Temperature 0 .. 255

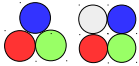

Load Type: RGB & RGBW

Ch.	Function	Map: Dimmer
1	Master Dimmer	Dimmer (Brightness Value) 0 .. 255

Ch.	Function	Map: Dim to Warm
1	Master Dimmer	Dimmer (Brightness Value) 0 .. 255

Ch.	Function	Map: Tunable white
1	Master Dimmer	Dimmer (Brightness Value) 0 .. 255
2	Color Correction	Color Temperature Correction 0 .. 255

Ch.	Function	Smart HSV
1	Master Dimmer	Master Dimmer (Brightness Value) 0 .. 255
2	Color Correction	Color Temperature Correction 0 .. 255
3	Hue	Hue 0 .. 255
4	Hue Rotation (rainbow) Time	Hue Fine 0 .. 15 Hold 16 .. 25 30min 26 .. 51 15min 52 .. 76 6min 77 .. 102 3min 103..127 1min 128..153 30s 154..179 15s 180..204 6s 205..230 3s 231..254
5	Saturation	Saturation 0 .. 255
6	Strobo Rate	fix 0 .. 15 blackout 16 .. 31 1fps 32 .. 47 2fps 48 .. 63 3fps 64 .. 79 4fps 80 .. 95 5fps 96 .. 111 6fps 112..127 7fps 128..143 8fps 144..159 9fps 160..175 10fps 176..191 12fps 192..207 14fps 208..223 16fps 224..239 240..255

Ch.	Function	Map: RGB
1	R	R 0 .. 255
2	G	G 0 .. 255
3	B	B 0 .. 255

Ch.	Function	Map: RGBW
1	R	R 0 .. 255
2	G	G 0 .. 255
3	B	B 0 .. 255
4	W	W 0 .. 255

Ch.	Function	Map: MRGB+
1	Master Dimmer	Master Dimmer (Brightness Value) 0 .. 255
2	R	R 0 .. 255
3	G	G 0 .. 255
4	B	B 0 .. 255
5	Strobo Rate	fix blackout 1fps 2fps 3fps 4fps 5fps 6fps 7fps 8fps 9fps 10fps 12fps 14fps 16fps fix

Ch.	Function	Map: MRGBW+
1	Master Dimmer	Master Dimmer (Brightness Value) 0 .. 255
2	R	R 0 .. 255
3	G	G 0 .. 255
4	B	B 0 .. 255
5	W	W 0 .. 255
6	Strobo Rate	fix blackout 1fps 2fps 3fps 4fps 5fps 6fps 7fps 8fps 9fps 10fps 12fps 14fps 16fps fix

DMX Master/Slave

Example to Master/Slave connection

More DLD1248-4CV-DMX devices can be connected following a master/slave configuration. Master and Slave must be the same DIP-SWITCH configuration. To select the desired local command, DIP-SWITCH need to be set as explained in **Setup DMX MASTER/SLAVE** on page 19 and 20.

Comandi Locali
 es. Pulsanti N.A.

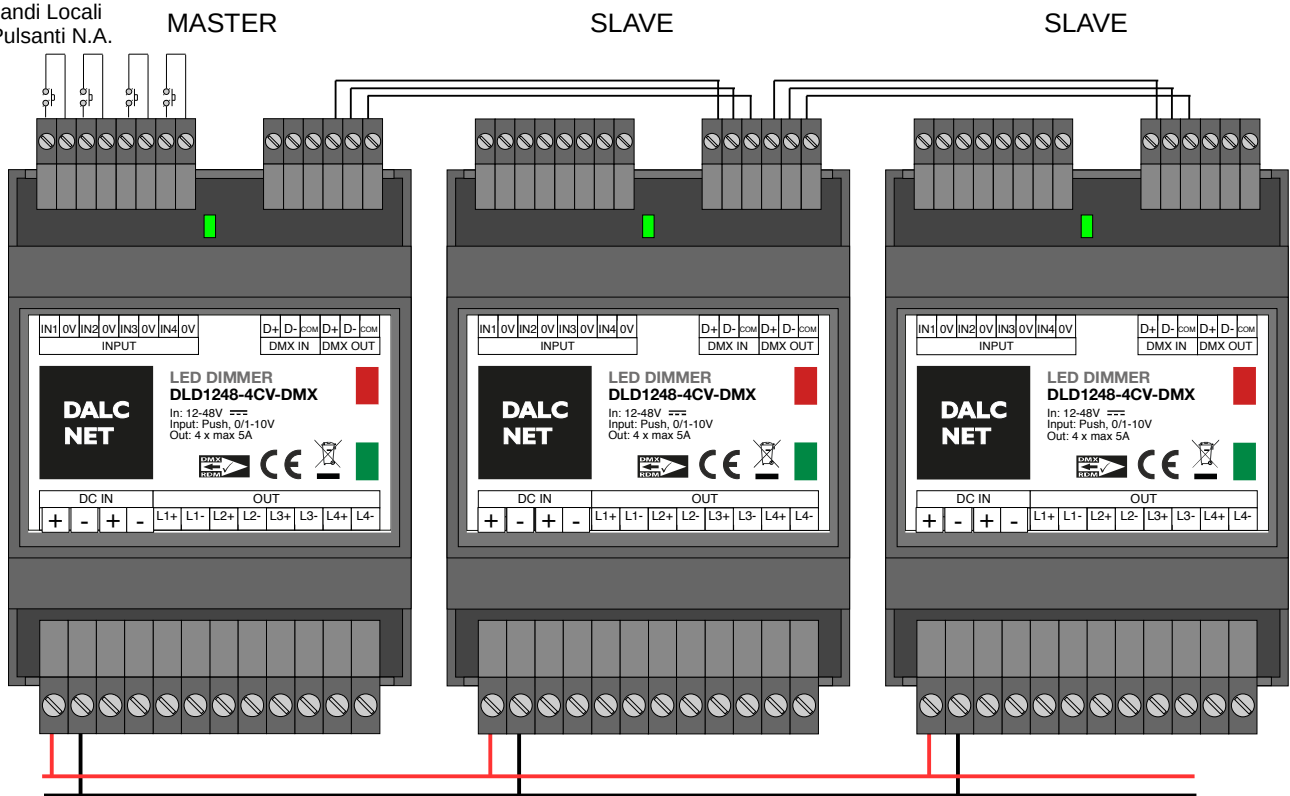

■ **SETUP DMX Master/Slave**

Master:

Note: Master and Slave must have setted the same map (switches from 4 to 6).

Default Master:



Master with FADE UP / FADE DOWN:

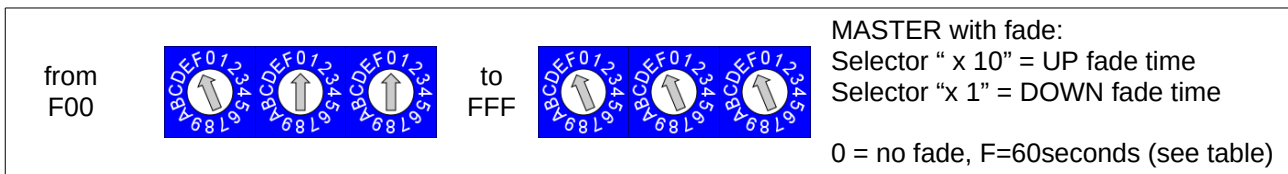

Fade times:

0	1	2	3	4	5	6	7	8	9	A	B	C	D	E	F
NO fade	0.5s	1s	2s	3s	4s	5s	6s	7s	8s	9s	10s	15s	20s	30s	60s

Examples:

Turn on/off without fade (no fade UP/DOWN): F00

Turn on without fade (no fade UP) and turn off fade of 5 seconds (fade DOWN): F06

Turn on fade of 1 seconds (fade UP) and turn off fade of 10 seconds (fade DOWN): F2B

Notes:

This function is available on maps: "Dimmer", "Dim to Warm", "Tunable White", "Smart Colors"

The Slaves follow master fade ramps.



DALCNET S.r.l.
 Registered office: via Meucci, 35 - 36040 Brendola (VI) - Italy
 Headquarters: via Meucci, 35 - 36040 Brendola (VI) - Italy
 Tel. + 39 0444 1836680/1867452 Fax. + 39 0444 1867453
 VAT: IT-04023100235
 info@dalcnet.com www.dalcnet.com

DLD1248 4 channels
 PRO
Device Manual
 FW 1.2



Made in Italy
 Rev. 2018-05-04
 pag. 20/24

Slave:

Note: Master and Slave must have setted the same map (switches from 4 to 6).



Default Slave:

E00  Slave

Slave: Color Wave effect (only in map "Smart HSV"):



Easy creates a "color wave" effect, adding a delay from the master phase synchronism. The delay is selected on each slave in step of 15°, from 0° (E00) to 345° (E23)

from E00  to E23 

Slave, Color Wave effect:
 00 = sync with master (no wave)
 01 = 15° phase
 ...
 08 = 120° phase
 ...
 16 = 240° phase
 ...
 23 = 345° phase

Phase delays:

E00	E01	E02	E03	E04	E05	E06	E07	E08	E09	E10	E11	E12	E13	E14	E15	E16	E17	E18	E19	E20	E21	E22	E23
0°	15°	30°	45°	60°	75°	90°	105°	120°	135°	150°	165°	180°	195°	210°	225°	240°	255°	270°	285°	300°	315°	330°	345°

Examples:

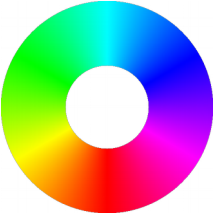
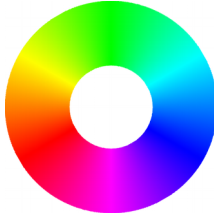
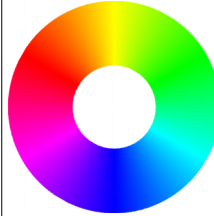
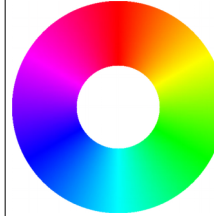
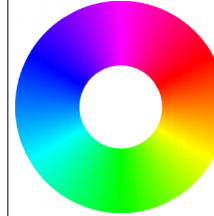
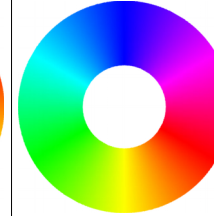
					
E00 0° Sync with master	E04 60° phase delay	E08 120° phase delay R → B, G → R, B → G	E12 180° phase delay Complementary color	E16 240° phase delay R → G, G → B, B → R	E20 300° phase delay

■ **MODBUS SETUP**

In **MODBUS SETUP** in the "slave" condition the outputs LEDs are managed by an external MODBUS RTU master controller (RS-485).

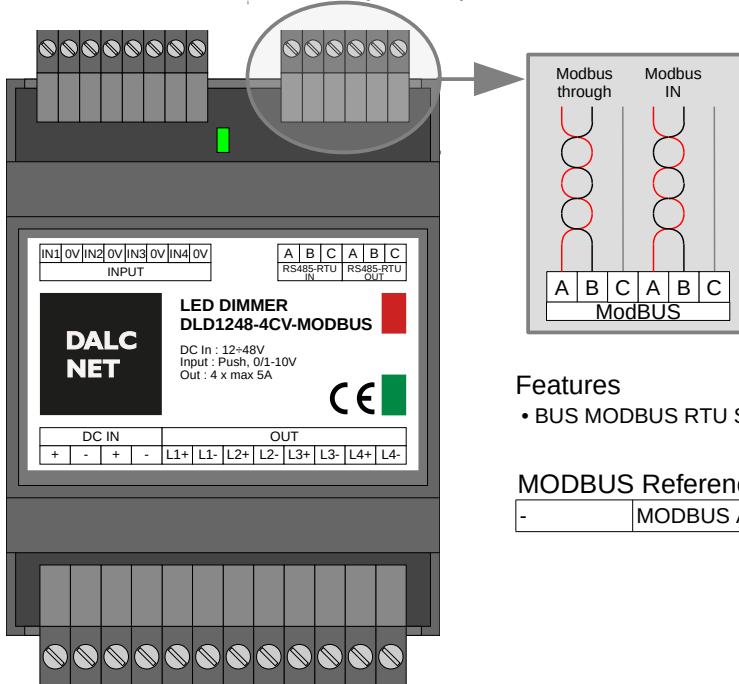

Features

- BUS MODBUS RTU SLAVE on RS485

MODBUS Reference standards

-	MODBUS APPLICATION PROTOCOL SPECIFICATION V1.1b
---	---

Onboard led:







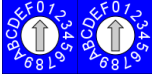
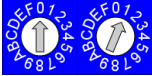
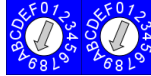

- In the case of bus error, the led blinks fast (2 pulsed per second).
- In the case of no bus detected, led blinks slow (1 pulse per second).
- In the case of data link active, the led stands on.

Relation with local commands

- **LOCAL COMMAND SET UP AS N.O. PUSH BUTTON:**
 The local command is always active even in presence of the bus. If you use the local command, the available variables are updated in read/write to the bus. Instead if you use the bus, the status of local command is updated. This setting allows you to control the output status whether local command or bus at the same time. The local command has always priority to bus command. The status of the device is visible from bus and can be viewed by a supervision system.
- **LOCAL COMMAND SET UP AS 0..5V, 0..10V OR SWITCH:**
 At power-up, in case of absence of connection to the BUS, local control is active. When the BUS is detected, the control passes to the BUS. It remains to the BUS until there is signal. In absence of signal, the control passes immediately to the local command.

Addressing by selectors

Selectors x10, x1 (middle and right)			
Modbus	00 (default):		Default modbus ID (1)
	from 01		to 99  Modbus ID

Selector x100 (left)								
Modbus								
	0 115200 baud 8N1	1 115200 baud 8E1	2 38400 baud 8N1	3 38400 baud 8E1	4 19200 baud 8N1	5 19200 baud 8E1	6 9600 baud 8N1	7 9600 baud 8E1

CHANNELS MAP – MODBUS

Load Type: White - up to 4 loads

Var	Function	Map: Dimmer
0	Dimmer 1	Dimmer (Brightness Value) 0 .. 255
1	Dimmer 2	Dimmer (Brightness Value) 0 .. 255
2	Dimmer 3	Dimmer (Brightness Value) 0 .. 255
3	Dimmer 4	Dimmer (Brightness Value) 0 .. 255

Load Type: White - Parallel outs (Macro dimmer)

Var	Function	Map: Dimmer
0	Dimmer	Dimmer (Brightness Value) 0 .. 255

Load Type: Tunable White – up to 2 loads

Var	Function	Map: Dimmer
0	Dimmer 1	Dimmer (Brightness Value) 0 .. 255
1	Dimmer 2	Dimmer (Brightness Value) 0 .. 255

Var	Function	Map: Dim to Warm
0	Dimmer 1	Dimmer (Brightness Value) 0 .. 255
1	Dimmer 2	Dimmer (Brightness Value) 0 .. 255

Var	Function	Map: Tunable white
0	Dimmer 1	Dimmer (Brightness Value) 0 .. 255
1	Color Correction 1	Color Correction Temperature 0 .. 255
2	Dimmer 2	Dimmer (Brightness Value) 0 .. 255
3	Color Correction 2	Color Correction Temperature 0 .. 255

Load Type: Tunable White – Parallel outs

Var	Function	Map: Dimmer
0	Dimmer 1	Dimmer (Brightness Value) 0 .. 255

Var	Function	Map: Dim to Warm
0	Dimmer	Dimmer (Brightness Value) 0 .. 255

Var	Function	Map: Tunable white
0	Dimmer	Dimmer (Brightness Value) 0 .. 255
1	Color Correction	Color Correction Temperature 0 .. 255



Load Type: RGB & RGBW

Var	Function	Map: Dimmer
0	Master Dimmer	Dimmer (Brightness Value) 0 .. 255

Var	Function	Map: Dim to Warm
0	Master Dimmer	Dimmer (Brightness Value) 0 .. 255

Var	Function	Map: Tunable white
0	Master Dimmer	Dimmer (Brightness Value) 0 .. 255
1	Color Correction	Color Temperature Correction 0 .. 255

Var	Function	Smart HSV
0	Master Dimmer	Master Dimmer (Brightness Value) 0 .. 255
1	Color Correction	Color Temperature Correction 0 .. 255
2	Hue	Hue 0 .. 255
3	Hue Rotation (rainbow) Time	Hue Fine 0 .. 15 Hold 16 .. 25 30min 26 .. 51 15min 52 .. 76 6min 77 .. 102 3min 103..127 1min 128..153 30s 154..179 15s 180..204 6s 205..230 3s 231..254
4	Saturation	Saturation 0 .. 255
5	Strobo Rate	fix 0 .. 15 blackout 16 .. 31 1fps 32 .. 47 2fps 48 .. 63 3fps 64 .. 79 4fps 80 .. 95 5fps 96 .. 111 6fps 112..127 7fps 128..143 8fps 144..159 9fps 160..175 10fps 176..191 12fps 192..207 14fps 208..223 16fps 224..239 240..255

Var	Function	Map: RGB
0	R	R 0 .. 255
1	G	G 0 .. 255
2	B	B 0 .. 255

Var	Function	Map: RGBW
0	R	R 0 .. 255
1	G	G 0 .. 255
2	B	B 0 .. 255
3	W	W 0 .. 255

Var	Function	Map: MRGB+
0	Master Dimmer	Master Dimmer (Brightness Value) 0 .. 255
1	R	R 0 .. 255
2	G	G 0 .. 255
3	B	B 0 .. 255
4	Strobo Rate	fix blackout 1fps 2fps 3fps 4fps 5fps 6fps 7fps 8fps 9fps 10fps 12fps 14fps 16fps fix

Var	Function	Map: MRGBW+
0	Master Dimmer	Master Dimmer (Brightness Value) 0 .. 255
1	R	R 0 .. 255
2	G	G 0 .. 255
3	B	B 0 .. 255
4	W	W 0 .. 255
5	Strobo Rate	fix blackout 1fps 2fps 3fps 4fps 5fps 6fps 7fps 8fps 9fps 10fps 12fps 14fps 16fps fix



SUPPORTED FUNCTIONS FOR READING AND WRITING – MODBUS RTU

Function code		
0x01	Read Coils	✘
0x02	Read Discrete Inputs	✘
0x03	Read Holding Registers	✔
0x04	Read Input Register	✘
0x05	Write Single Coil	✘
0x06	Write Single Register	✔
0x07	Read Exception Status	✘
0x08	Diagnostic	✘
0c0B	Get Com Event Counter	✘
0x0C	Get Com Event Log	✘
0x0F	Write Multiple Coils	✘
0x10	Write Multiple Registers	✔
0x11	Report Server ID	✘
0x14	Read File Record	✘
0x15	Write File Record	✘
0x16	Mask Write Register	✘
0x17	Read/Write Multiple Registers	✘
0x18	Read FIFO queue	✘
0x2B	Read Device Identification	✘