



P-DUKE POWER

EED40 · EED40W Series

DC-DC Converter
Up to 40 Watts

3
YEARS
WARRANTY

ROHS
COMPLIANT

REACH
COMPLIANT



Automation



Datacom



IPC



Industry



Measurement



Telecom



Automobile



Boat



Charger



Medical



PV



Railway

c

1600
VDC
Isolation
Voltage

4 : 1
Wide
Input
Range

2 : 1
Input
Range

6
sided
Shielding

LOW
Standby
Power

NO
Min. Load
Required

REMOTE
ON
OFF

OCP

OTP

OVP

SCP

UVP

PART NUMBER STRUCTURE

EED40 - 48 S 05 W - N HC

Series Name	Input Voltage (VDC)	Output Quantity	Output Voltage (VDC)	Input Range	Remote On/Off Options	Assembly Options		
EED40 - 48	12:9~18 24:18~36 48:36~75	S:Single	3P3: 3.3	□: 2:1	□:Positive logic N:Negative logic	□: None HC: 7G-0020C-F; H=0.22" (※NRND) HC1: 7GA0120P01-F; H=0.3" HC2: 7GA0121P01-F; H=0.5" HC3: 7GA0122P01-F; H=0.8"		
			05: 5					
			12: 12					
	D:Dual	15: 15	※NRND: Not recommended for new designs					
		24: 24						
		12: ±12						
EED40 - 48	24:9~36 48:18~75	S:Single	3P3: 3.3	W: 4:1	□:Positive logic N:Negative logic	□: None HC: 7G-0020C-F; H=0.22" (※NRND) HC1: 7GA0120P01-F; H=0.3" HC2: 7GA0121P01-F; H=0.5" HC3: 7GA0122P01-F; H=0.8"		
			05: 5					
			12: 12					
	D:Dual	15: 15	※NRND: Not recommended for new designs					
		24: 24						
		12: ±12						
EED40 - 48	24:9~36 48:18~75	S:Single	15: 15	W: 4:1	□:Positive logic N:Negative logic	□: None HC: 7G-0020C-F; H=0.22" (※NRND) HC1: 7GA0120P01-F; H=0.3" HC2: 7GA0121P01-F; H=0.5" HC3: 7GA0122P01-F; H=0.8"		
			24: 24					
			48: 48					
EED40 - 48	24:9~36 48:18~75	S:Single	53: 53	W: 4:1			□:Positive logic N:Negative logic	□: None HC: 7G-0020C-F; H=0.22" (※NRND) HC1: 7GA0120P01-F; H=0.3" HC2: 7GA0121P01-F; H=0.5" HC3: 7GA0122P01-F; H=0.8"
			12: 12					
			15: 15					
EED40 - 48	24:9~36 48:18~75	D:Dual	24: 24	W: 4:1	□:Positive logic N:Negative logic	□: None HC: 7G-0020C-F; H=0.22" (※NRND) HC1: 7GA0120P01-F; H=0.3" HC2: 7GA0121P01-F; H=0.5" HC3: 7GA0122P01-F; H=0.8"		
			48: 48					
			53: 53					
EED40 - 48	24:9~36 48:18~75	D:Dual	12: ±12	W: 4:1			□:Positive logic N:Negative logic	□: None HC: 7G-0020C-F; H=0.22" (※NRND) HC1: 7GA0120P01-F; H=0.3" HC2: 7GA0121P01-F; H=0.5" HC3: 7GA0122P01-F; H=0.8"
			15: ±15					
			24: ±24					

TECHNICAL SPECIFICATION All specifications are typical at nominal input, full load and 25°C unless otherwise noted

Model Number	Input Range	Output Voltage	Output Current @Full Load	Input Current @ No Load	Efficiency	Maximum Capacitor Load
	VDC	VDC	mA	mA	%	µF
EED40-12S3P3	9 ~ 18	3.3	12200	20	89	22000
EED40-12S05	9 ~ 18	5	8000	20	90	12000
EED40-12S12	9 ~ 18	12	3333	20	91	2000
EED40-12S15	9 ~ 18	15	2666	20	91	1300
EED40-12S24	9 ~ 18	24	1666	20	90	490
EED40-12D12	9 ~ 18	±12	±1666	20	90	±980
EED40-12D15	9 ~ 18	±15	±1333	20	90	±630
EED40-12D24	9 ~ 18	±24	±833	20	91	±250
EED40-24S3P3	18 ~ 36	3.3	12200	15	89.5	22000
EED40-24S05	18 ~ 36	5	8000	15	92	12000
EED40-24S12	18 ~ 36	12	3333	15	92	2000
EED40-24S15	18 ~ 36	15	2666	15	93	1300
EED40-24S24	18 ~ 36	24	1666	15	91	490
EED40-24D12	18 ~ 36	±12	±1666	15	91	±980
EED40-24D15	18 ~ 36	±15	±1333	15	91	±630
EED40-24D24	18 ~ 36	±24	±833	15	91	±250
EED40-48S3P3	36 ~ 75	3.3	12200	10	90	22000
EED40-48S05	36 ~ 75	5	8000	10	91	12000
EED40-48S12	36 ~ 75	12	3333	10	92	2000
EED40-48S15	36 ~ 75	15	2666	10	92	1300
EED40-48S24	36 ~ 75	24	1666	10	92	490
EED40-48D12	36 ~ 75	±12	±1666	10	91	±980
EED40-48D15	36 ~ 75	±15	±1333	10	91	±630
EED40-48D24	36 ~ 75	±24	±833	10	92	±250
EED40-24S3P3W	9 ~ 36	3.3	12200	15	89.5	22000
EED40-24S05W	9 ~ 36	5	8000	15	92	12000
EED40-24S12W	9 ~ 36	12	3333	15	92	2000
EED40-24S15W	9 ~ 36	15	2666	15	93	1300
EED40-24S24W	9 ~ 36	24	1666	15	91	490
EED40-24S48W	9 ~ 36	48	833	15	91	120
EED40-24S53W	9 ~ 36	53	755	15	91.5	100
EED40-24D12W	9 ~ 36	±12	±1666	15	91	±980
EED40-24D15W	9 ~ 36	±15	±1333	15	91	±630
EED40-24D24W	9 ~ 36	±24	±833	15	91	±250
EED40-48S3P3W	18 ~ 75	3.3	12200	10	90	22000
EED40-48S05W	18 ~ 75	5	8000	10	91	12000
EED40-48S12W	18 ~ 75	12	3333	10	92	2000
EED40-48S15W	18 ~ 75	15	2666	10	92	1300
EED40-48S24W	18 ~ 75	24	1666	10	92	490
EED40-48S48W	18 ~ 75	48	833	10	92	120
EED40-48S53W	18 ~ 75	53	755	10	92	100
EED40-48D12W	18 ~ 75	±12	±1666	10	91	±980
EED40-48D15W	18 ~ 75	±15	±1333	10	91	±630
EED40-48D24W	18 ~ 75	±24	±833	10	92	±250

INPUT SPECIFICATIONS						
Parameter	Conditions		Min.	Typ.	Max.	Unit
Operating input voltage range	2:1	12Vin(nom)	9	12	18	VDC
		24Vin(nom)	18	24	36	
		48Vin(nom)	36	48	75	
	(W) 4:1	24Vin(nom)	9	24	36	VDC
		48Vin(nom)	18	48	75	
Start up voltage	2:1	12Vin(nom)			9	VDC
		24Vin(nom)			18	
		48Vin(nom)			36	
	(W) 4:1	24Vin(nom)			9	VDC
		48Vin(nom)			18	
Shutdown voltage	2:1	12Vin(nom)	7	8	8.8	VDC
		24Vin(nom)	15	16	17.5	
		48Vin(nom)	32	33	35	
	(W) 4:1	24Vin(nom)	7	8	8.8	VDC
		48Vin(nom)	15	16	17.5	
Start up time	Constant resistive load	Power up		30	60	ms
Input surge voltage	1 second, max.	12Vin(nom)			25	VDC
		24Vin(nom)			50	
		48Vin(nom)			100	
	1 second, max.	24Vin(nom)			50	VDC
		48Vin(nom)			100	
Input filter				Pi type		
Remote ON/OFF	Referred to -Vin pin	Positive logic	DC-DC ON	Open or 3 ~ 12VDC		
		(Standard)	DC-DC OFF	Short or 0 ~ 1.2VDC		
		Negative logic	DC-DC ON	Short or 0 ~ 1.2VDC		
		(Option)	DC-DC OFF	Open or 3 ~ 12VDC		
		Input current of Ctrl pin	-0.5		1	mA
		Remote off input current		3		mA

OUTPUT SPECIFICATIONS						
Parameter	Conditions		Min.	Typ.	Max.	Unit
Voltage accuracy			-1.0		+1.0	%
Line regulation	Low Line to High Line at Full Load		-0.2		+0.2	%
Load regulation	No Load to Full Load	Single	-0.3		+0.3	%
		Dual	-0.5		+0.5	
Cross regulation	Asymmetrical load 25%/100% FL	Dual	-5.0		+5.0	%
Voltage adjustability	Single output	Other	-10		+10	%
		15Vout, 24Vout	-10		+20	
Ripple and noise	Measured by 20MHz bandwidth With a 1μF/100V X7R MLCC	3.3Vout, 5Vout		75		mVp-p
		12Vout, 15Vout		100		
		24Vout		150		
		48Vout, 53Vout		300		
Temperature coefficient			-0.02		+0.02	%/°C
Transient response recovery time	25% load step change			250		μs
Over voltage protection	Zener diode clamp	3.3Vout		3.9		VDC
		5Vout		6.2		
		12Vout		15		
		15Vout		20		
		24Vout		30		
		48Vout		60		
		53Vout		63		
Over load protection	% of Iout rated; Hiccup mode			150		%
Short circuit protection			Continuous, automatics recovery			

GENERAL SPECIFICATIONS

Parameter	Conditions	Min.	Typ.	Max.	Unit
Isolation voltage	1 minute Input to Output Input (Output) to Case	1600 1600			VDC
Isolation resistance	500VDC	1			GΩ
Isolation capacitance				1500	pF
Switching frequency		225	250	275	kHz
Safety approvals	IEC/ UL/ EN62368-1			UL:E193009 CB:UL(Demko)	
Case material					Copper
Base material					FR4 PCB
Potting material					Silicone (UL94 V-0)
Weight					34g (1.2oz)
MTBF	MIL-HDBK-217F, Full load				1.245 x 10 ⁶ hrs

ENVIRONMENTAL SPECIFICATIONS

Parameter	Conditions	Min.	Typ.	Max.	Unit
Operating ambient temperature	With derating	-40		+105	°C
Maximum case temperature				105	°C
Over temperature protection			115		°C
Storage temperature range		-55		+125	°C
Thermal impedance	Natural convection Without Heat-sink With Heat-sink HC HC1 HC2 HC3		10.8 10.3 9.3 7.7 6.2		°C/W
Thermal shock					MIL-STD-810F
Shock					MIL-STD-810F
Vibration					MIL-STD-810F
Relative humidity					5% to 95% RH

EMC SPECIFICATIONS

Parameter	Conditions	Level
EMI	EN55032 With external components	Class A, Class B
EMS	EN55024	
ESD	EN61000-4-2 Air ± 8kV and Contact ± 6kV	Perf. Criteria A
Radiated immunity	EN61000-4-3 10V/m	Perf. Criteria A
Fast transient	EN61000-4-4 ± 2kV	Perf. Criteria A
	EED40-12□□□□ With 2 pcs of aluminum electrolytic capacitor (Nippon chemi-con KY series, 220μF/100V) and a TVS (SMDJ36A, 36V, 3000Watt peak pulse power) in parallel.	
	EED40-24□□□□ With 2 pcs of aluminum electrolytic capacitor (Nippon chemi-con KY series, 220μF/100V) and a TVS (SMDJ58A, 58V, 3000Watt peak pulse power) in parallel.	
	EED40-48□□□□ With 2 pcs of aluminum electrolytic capacitor (Nippon chemi-con KY series, 220μF/100V) and a TVS (SMDJ120A, 120V, 3000Watt peak pulse power) in parallel.	

EMC SPECIFICATIONS(CONTINUED)

Parameter	Conditions	Level
Surge	EN61000-4-5 ± 2kV EED40-12□□□□ With 2 pcs of aluminum electrolytic capacitor (Nippon chemi-con KY series, 220μF/100V) and a TVS (SMDJ36A, 36V, 3000Watt peak pulse power) in parallel. EED40-24□□□□ With 2 pcs of aluminum electrolytic capacitor (Nippon chemi-con KY series, 220μF/100V) and a TVS (SMDJ58A, 58V, 3000Watt peak pulse power) in parallel. EED40-48□□□□ With 2 pcs of aluminum electrolytic capacitor (Nippon chemi-con KY series, 220μF/100V) and a TVS (SMDJ120A, 120V, 3000Watt peak pulse power) in parallel.	Perf. Criteria A
Conducted immunity	EN61000-4-6 10Vr.m.s	Perf. Criteria A
Power frequency magnetic field	EN61000-4-8 100A/m continuous; 1000A/m 1 second	Perf. Criteria A

CHARACTERISTIC CURVE

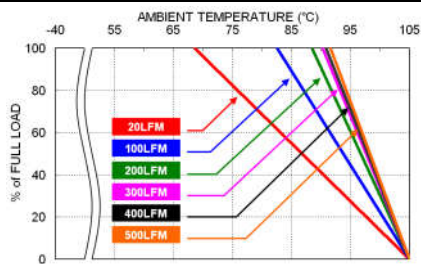

EED40-24S05W Derating Curve

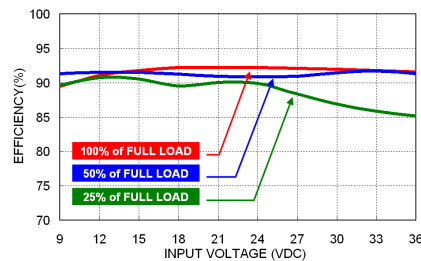

EED40-24S05W Efficiency vs. Input Voltage

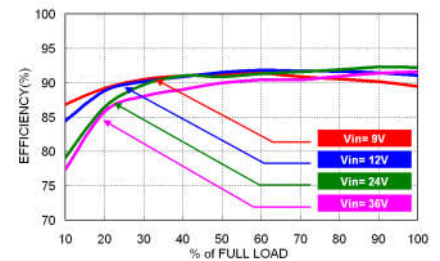

EED40-24S05W Efficiency vs. Output Load

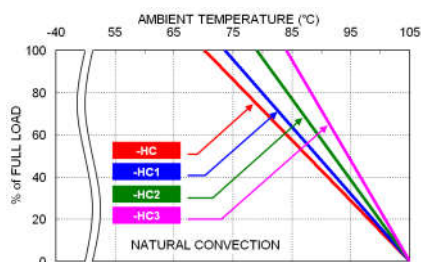

EED40-24S05W Derating Curve With Heat-sink

FUSE CONSIDERATION

This power module is not internally fused. An input line fuse must always be used.

This encapsulated power module can be used in a wide variety of applications, ranging from simple stand-alone operation to an integrated part of sophisticated power architecture.

To maximum flexibility, internal fusing is not included; however, to achieve maximum safety and system protection, always use an input line fuse.

The input line fuse suggest as below :

Model	Fuse Rating (A)	Fuse Type
EED40-12□□□□、24□□□□W	8	Fast-Acting
EED40-24□□□□、48□□□□W	4	Slow-Blow
EED40-48□□□□	2	Slow-Blow

The table based on the information provided in this data sheet on inrush energy and maximum DC input current at low Vin.

MECHANICAL DRAWING

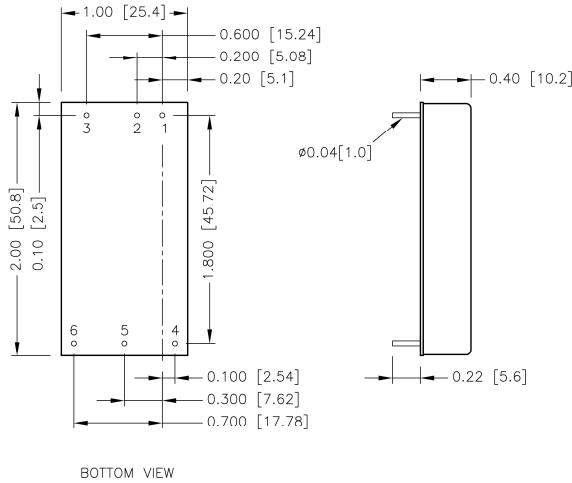

PIN CONNECTION

PIN	SINGLE	DUAL
1	+ Vin	+ Vin
2	- Vin	- Vin
3	Ctrl	Ctrl
4	+ Vout	+ Vout
5	- Vout	Com
6	Trim	- Vout

- All dimensions in inch [mm]
Tolerance :x.xx±0.02 [x.x±0.5]
x.xxx±0.010 [x.xx±0.25]
- Pin dimension tolerance ±0.004[0.10]

RECOMMENDED PAD LAYOUT

Standard

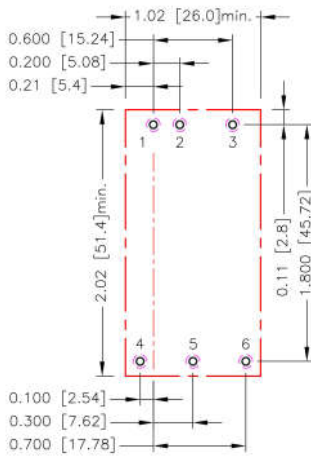

-HC

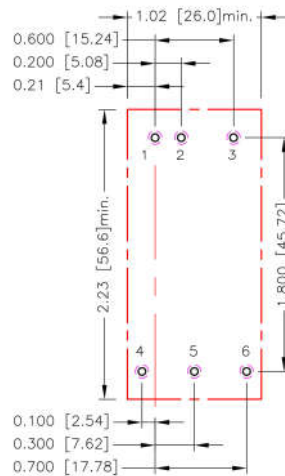

-HC1、-HC2、-HC3

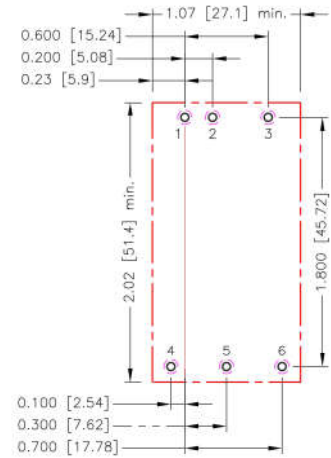

All dimensions in inch[mm]
 Pad size(lead free recommended)
 Through hole 1.2.3.4.5.6: $\phi 0.051 [1.30]$
 Top view pad 1.2.3.4.5.6: $\phi 0.064 [1.63]$
 Bottom view pad 1.2.3.4.5.6: $\phi 0.102 [2.60]$

THERMAL CONSIDERATIONS

The power module operates in a variety of thermal environments.

However, sufficient cooling should be provided to help ensure reliable operation of the unit.

Heat is removed by conduction, convection, and radiation to the surrounding Environment.

Proper cooling can be verified by measuring the point as the figure below.

The temperature at this location should not exceed "Maximum case temperature".

When Operating, adequate cooling must be provided to maintain the test point temperature at or below "Maximum case temperature".

You can limit this Temperature to a lower value for extremely high reliability.

- Thermal test condition with vertical direction by natural convection (20LFM).

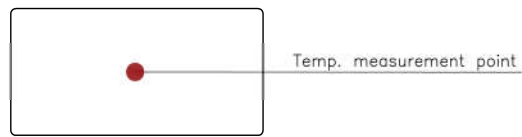

TOP VIEW

HEAT-SINK TYPE OPTIONS

EED40-□□□□□W-**HC**
7G-0020C-F

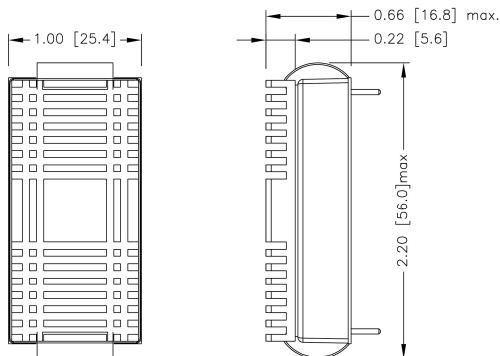

SIDE VIEW

EED40-□□□□□W-**HC1**
7GA0120P01-F

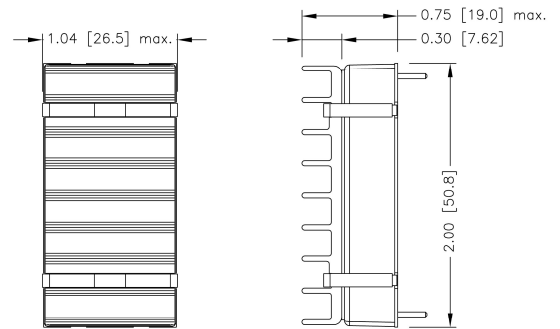

SIDE VIEW

EED40-□□□□□W-**HC2**
7GA0121P01-F

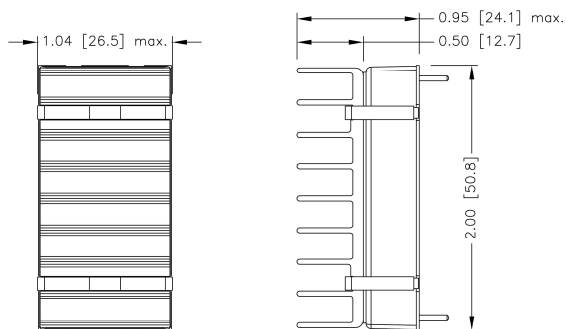

SIDE VIEW

EED40-□□□□□W-**HC3**
7GA0122P01-F

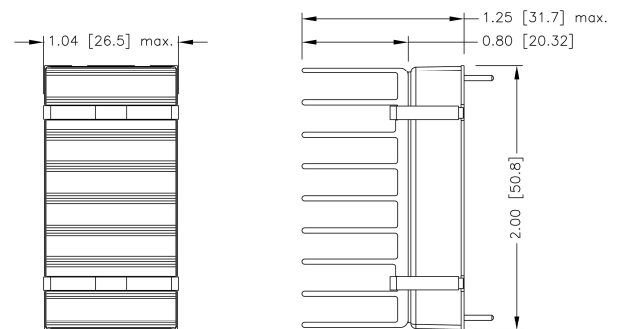

SIDE VIEW

- All dimensions in inch [mm]
- Tolerance :x.xx±0.02 [x.x±0.5]
x.xxx±0.010 [x.xx±0.25]

OUTPUT VOLTAGE ADJUSTMENT

It allows the user to increase or decrease the output voltage of the module.

This is accomplished by connecting an external resistor between the Trim pin and either the +Vout or -Vout pins.

With an external resistor between the Trim and -Vout pin, the output voltage increases.

With an external resistor between the Trim and +Vout pin, the output voltage decreases.

The external Trim resistor needs to be at least 1/8W of rated power.

EXTERNAL OUTPUT TRIMMING

Output can be externally trimmed by using the method shown below.

Trim-up

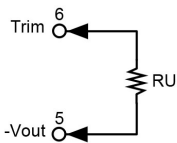

□□S3P3、□□S3P3W

ΔV (%)	1	2	3	4	5	6	7	8	9	10
Vout (V)	3.333	3.366	3.399	3.432	3.465	3.498	3.531	3.564	3.597	3.630
RU (k Ω)	43.179	21.758	13.410	8.966	6.206	4.325	2.961	1.927	1.115	0.462

□□S05、□□S05W

ΔV (%)	1	2	3	4	5	6	7	8	9	10
Vout (V)	5.05	5.10	5.15	5.20	5.25	5.30	5.35	5.40	5.45	5.50
RU (k Ω)	35.360	16.244	9.752	6.483	4.514	3.198	2.257	1.550	1.000	0.559

□□S12、□□S12W

ΔV (%)	1	2	3	4	5	6	7	8	9	10
Vout (V)	12.12	12.24	12.36	12.48	12.60	12.72	12.84	12.96	13.08	13.20
RU (k Ω)	392.864	172.175	101.446	66.591	45.837	32.068	22.264	14.929	9.234	4.685

□□S15、□□S15W

ΔV (%)	1	2	3	4	5	6	7	8	9	10
Vout (V)	15.15	15.30	15.45	15.60	15.75	15.90	16.05	16.20	16.35	16.50
RU (k Ω)	413.163	198.115	125.754	89.445	67.618	53.050	42.636	34.820	28.739	23.872
ΔV (%)	11	12	13	14	15	16	17	18	19	20
Vout (V)	16.65	16.80	16.95	17.10	17.25	17.40	17.55	17.70	17.85	18.00
RU (k Ω)	19.888	16.568	13.759	11.350	9.262	7.434	5.822	4.389	3.106	1.951

□□S24、□□S24W

ΔV (%)	1	2	3	4	5	6	7	8	9	10
Vout (V)	24.24	24.48	24.72	24.96	25.20	25.44	25.68	25.92	26.16	26.40
RU (k Ω)	947.146	472.772	303.499	216.605	163.724	128.153	102.589	83.329	68.298	56.240
ΔV (%)	11	12	13	14	15	16	17	18	19	20
Vout (V)	26.64	26.88	27.12	27.36	27.60	27.84	28.08	28.32	28.56	28.80
RU (k Ω)	46.353	38.099	31.104	25.101	19.892	15.330	11.302	7.718	4.509	1.619

□□S48W

ΔV (%)	1	2	3	4	5	6	7	8	9	10
Vout (V)	48.48	48.96	49.44	49.92	50.40	50.88	51.36	51.84	52.32	52.80
RU (k Ω)	531.639	226.403	131.987	86.042	58.867	40.910	28.162	18.642	11.263	5.376

□□S53W

ΔV (%)	1	2	3	4	5	6	7	8	9	10
Vout (V)	53.53	54.06	54.59	55.12	55.65	56.18	56.71	57.24	57.77	58.30
RU (k Ω)	626.943	246.365	140.489	90.768	61.891	43.022	29.726	19.853	12.231	6.169

OUTPUT VOLTAGE ADJUSTMENT(CONTINUED)

Trim-down

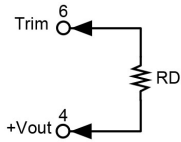

□□S3P3、□□S3P3W

ΔV (%)	1	2	3	4	5	6	7	8	9	10
Vout (V)	3.267	3.234	3.201	3.168	3.135	3.102	3.069	3.036	3.003	2.970
RD (k Ω)	68.728	31.256	18.592	12.227	8.398	5.841	4.012	2.639	1.570	0.715

□□S05、□□S05W

ΔV (%)	1	2	3	4	5	6	7	8	9	10
Vout (V)	4.95	4.90	4.85	4.80	4.75	4.70	4.65	4.60	4.55	4.50
RD (k Ω)	46.686	20.817	12.360	8.162	5.653	3.984	2.794	1.903	1.210	0.656

□□S12、□□S12W

ΔV (%)	1	2	3	4	5	6	7	8	9	10
Vout (V)	11.88	11.76	11.64	11.52	11.40	11.28	11.16	11.04	10.92	10.80
RD (k Ω)	435.294	201.116	120.429	79.573	54.894	38.371	26.535	17.639	10.709	5.157

□□S15、□□S15W

ΔV (%)	1	2	3	4	5	6	7	8	9	10
Vout (V)	14.85	14.70	14.55	14.40	14.25	14.10	13.95	13.80	13.65	13.50
RD (k Ω)	302.154	132.978	78.547	51.685	35.680	25.055	17.489	11.826	7.429	3.916

□□S24、□□S24W

ΔV (%)	1	2	3	4	5	6	7	8	9	10
Vout (V)	23.76	23.52	23.28	23.04	22.80	22.56	22.32	22.08	21.84	21.60
RD (k Ω)	736.063	326.672	192.473	125.790	85.913	59.383	40.459	26.282	15.263	6.454

□□S48W

ΔV (%)	1	2	3	4	5	6	7	8	9	10
Vout (V)	47.52	47.04	46.56	46.08	45.60	45.12	44.64	44.16	43.68	43.20
RD (k Ω)	558.604	257.390	153.744	101.292	69.616	48.413	33.225	21.811	12.920	5.798

□□S53W

ΔV (%)	1	2	3	4	5	6	7	8	9	10
Vout (V)	52.47	51.94	51.41	50.88	50.35	49.82	49.29	48.76	48.23	47.70
RD (k Ω)	551.986	256.323	153.564	101.358	69.765	48.589	33.408	21.991	13.093	5.962