



P-DUKE POWER

RHK06W Series

DC-DC Converter
Up to 6 Watts

3
YEARS
WARRANTY

ROHS
COMPLIANT

REACH
COMPLIANT

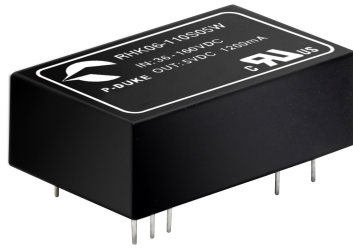

Railway



Automation



Datacom



IPC



Industry



Measurement



Telecom



Automobile



Boat



Charger



Medical



PV



3000 VAC
Reinforced
Insulation

4 : 1
Wide
Input
Range

Internal
EN55032
Class **A**
Filter

LOW
Standby
Power

NO
Min. Load
Required

**REMOTE
ON
OFF**

OCP

OVP

SCP

UVP

PART NUMBER STRUCTURE

Series Name	Input Voltage (VDC)	Output Quantity	Output Voltage (VDC)	Input Range	Trim Options
RHK06 -	110	S	05	W	T
	110:36~160	S:Single	3P3:3.3 05:5 12:12 15:15 24:24	4:1	<input type="checkbox"/> :No pin T:Trim
		D: Dual	05:±5 12:±12 15:±15		

TECHNICAL SPECIFICATION All specifications are typical at nominal input, full load and 25°C unless otherwise noted

Model Number	Input Range	Output Voltage	Output Current @ Full Load	Input Current @ No Load	Efficiency	Maximum Capacitor Load
	VDC	VDC	mA	mA	%	μF
RHK06-110S3P3W	36~160	3.3	1800	4	82.5	2100
RHK06-110S05W	36~160	5	1200	4	86	1500
RHK06-110S12W	36~160	12	500	4	86.5	260
RHK06-110S15W	36~160	15	400	4	86	210
RHK06-110S24W	36~160	24	250	4	86	75
RHK06-110D05W	36~160	±5	±600	4	82.5	± 860
RHK06-110D12W	36~160	±12	±250	4	86	± 150
RHK06-110D15W	36~160	±15	±200	4	86	± 110

INPUT SPECIFICATIONS							
Parameter	Conditions		Min.	Typ.	Max.	Unit	
Operating input voltage range	110Vin(nom)		36	110	160	VDC	
Start up voltage	110Vin(nom)					36 VDC	
Shutdown voltage	110Vin(nom)		32	34	35.8	VDC	
Start up time	Constant resistive load	Power up	30		60	ms	
		Remote ON/OFF	30		60		
Input surge voltage	1 second, max.	110Vin(nom)	200			VDC	
Input filter			Pi type				
Remote ON/OFF	Referred to -Vin pin	DC-DC ON	Open or 3 ~ 12VDC		mA		
		DC-DC OFF	Short or 0 ~ 1.2VDC				
		Input current of Ctrl pin	-0.5	0.5			
		Remote off input current	2.5				

OUTPUT SPECIFICATIONS						
Parameter	Conditions		Min.	Typ.	Max.	Unit
Voltage accuracy			-1.0		+1.0	%
Line regulation	Low Line to High Line at Full Load	Single	-0.2		+0.2	%
		Dual	-0.5		+0.5	
Load regulation	No Load to Full Load	Single	-0.2		+0.2	%
		Dual	-1.0		+1.0	
Cross regulation	Asymmetrical load 25%/100% FL		-5.0		+5.0	%
Voltage adjustability	Single	3.3Vout, 5Vout, 12Vout	-10		+10	%
		15Vout, 24Vout	-10		+20	
Ripple and noise	Dual	Measured by 20MHz bandwidth				
		With a 10μF/25V X7R MLCC	3.3Vout, 5Vout	50		mVp-p
			12Vout, 15Vout	75		
With a 4.7μF/50V X7R MLCC	24Vout	75				
Temperature coefficient			-0.02		+0.02	%/°C
Transient response recovery time	25% load step change		250			μs
Over voltage protection	Single	3.3Vout	3.7		5	VDC
		5Vout	5.6		7	
		12Vout	13.5		16	
		15Vout	18.3		22	
		24Vout	29.1		34.5	
	Dual	5Vout	5.6		7	
	12Vout	13.5		18.2		
	15Vout	17		22		
Over load protection	% of lout rated; Hiccup mode		150			%
Short circuit protection			Continuous, automatics recovery			

GENERAL SPECIFICATIONS

Parameter	Conditions	Min.	Typ.	Max.	Unit
Isolation voltage	1 minute (Reinforced insulation) Input to Output	3000			VAC
Isolation resistance	500VDC	1			GΩ
Isolation capacitance				1000	pF
Switching frequency		270	300	330	kHz
Safety approvals	IEC/ EN/ UL62368-1				UL:E193009 CB:UL(Demko)
Standard approvals	EN50155 EN45545-2				
Case material					Non-conductive black plastic
Base material					Non-conductive black plastic
Potting material					Silicone (UL94 V-0)
Weight					14g (0.48oz)
MTBF	MIL-HDBK-217F, Full load				3.036 x 10 ⁶ hrs

ENVIRONMENTAL SPECIFICATIONS

Parameter	Conditions	Min.	Typ.	Max.	Unit
Operating ambient temperature	With derating	-40		+105	°C
Maximum case temperature				105	°C
Storage temperature range		-55		+125	°C
Thermal impedance	Natural convection		18.91		°C/W
Thermal shock					MIL-STD-810F
Shock					EN61373, MIL-STD-810F
Vibration					EN61373, MIL-STD-810F
Relative humidity					5% to 95% RH

EMC SPECIFICATIONS

Parameter	Conditions	Level
EMI	EN55032, EN50121-3-2 Without external component With external components.	Class A Class B
EMS	EN55024, EN50121-3-2	
ESD	EN61000-4-2 Air ± 8kV and Contact ± 6kV	Perf. Criteria A
Radiated immunity	EN61000-4-3 20 V/m	Perf. Criteria A
Fast transient	EN61000-4-4 ±2kV	Perf. Criteria A
Surge	RHK06-110□□□W With 2 pcs of aluminum electrolytic capacitor (Nippon chemi-con KXJ series, 220μF/200V) and a TVS (SMBJ220A, 220V, 600Watt peak pulse power) in parallel.	
	EN61000-4-5 ±2kV	Perf. Criteria A
Conducted immunity	RHK06-110□□□W With 2 pcs of aluminum electrolytic capacitor (Nippon chemi-con KXJ series, 220μF/200V) and a TVS (SMBJ220A, 220V, 600Watt peak pulse power) in parallel.	
	EN61000-4-6 10 Vr.m.s	Perf. Criteria A
Power frequency magnetic field	EN61000-4-8 100A/m continuous; 1000A/m 1 second	Perf. Criteria A

CAUTION: This power module is not internally fused. An input line fuse must always be used.

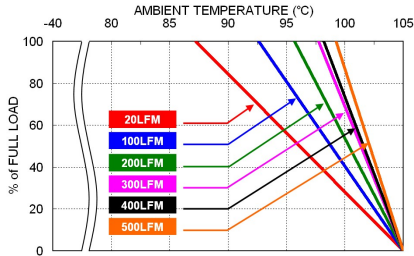
CHARACTERISTIC CURVE

RHK06-110S12W Derating Curve

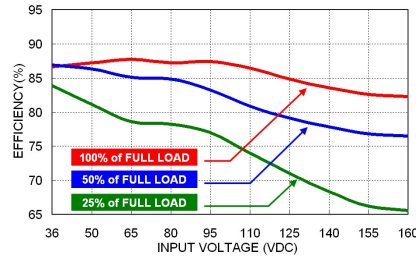

RHK06-110S12W Efficiency vs. Input Voltage

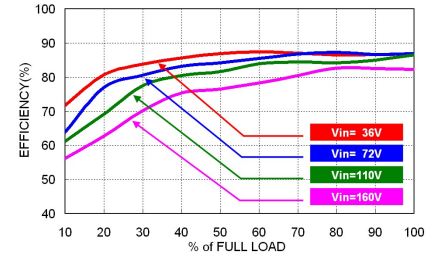

RHK06-110S12W Efficiency vs. Output Load

FUSE CONSIDERATION

This power module is not internally fused. An input line fuse must always be used.

This encapsulated power module can be used in a wide variety of applications, ranging from simple stand-alone operation to an integrated part of sophisticated power architecture.

To maximum flexibility, internal fusing is not included; however, to achieve maximum safety and system protection, always use an input line fuse.

The input line fuse suggest as below :

Model	Fuse Rating (A)	Fuse Type
RHK06-110□□W	0.5	Slow-Blow

The table based on the information provided in this data sheet on inrush energy and maximum DC input current at low V_{in} .

MECHANICAL DRAWING

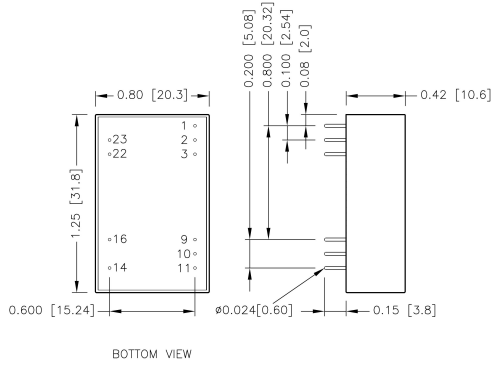

PIN CONNECTION

PIN	SINGLE	DUAL
1	Ctrl	Ctrl
2	- Vin	- Vin
3	- Vin	- Vin
9	NC	Common
10	Trim (option)	Trim (option)
11	NC	-Vout
14	+Vout	+Vout
16	-Vout	Common
22	+Vin	+Vin
23	+Vin	+Vin

- All dimensions in inch [mm]
- Tolerance :x.xx±0.02 [x.x±0.5]
x.xxx±0.010 [x.xx±0.25]
- Pin dimension tolerance ±0.004[0.10]

RECOMMENDED PAD LAYOUT

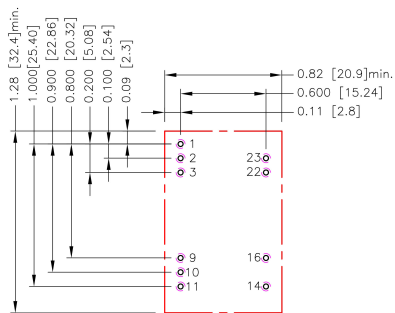

- All dimensions in inch[mm]
 Pad size(lead free recommended)
 Through hole 1.2.3.9.10.11.14.16.22.23: $\Phi 0.035[0.90]$
 Top view pad 1.2.3.9.10.11.14.16.22.23: $\Phi 0.044[1.13]$
 Bottom view pad 1.2.3.9.10.11.14.16.22.23: $\Phi 0.071[1.80]$

THEMAL CONSIDERATIONS

The power module operates in a variety of thermal environments. However, sufficient cooling should be provided to help ensure reliable operation of the unit. Heat is removed by conduction, convection, and radiation to the surrounding Environment. Proper cooling can be verified by measuring the point as the figure below. The temperature at this location should not exceed "Maximum case temperature". When Operating, adequate cooling must be provided to maintain the test point temperature at or below "Maximum case temperature". You can limit this Temperature to a lower value for extremely high reliability.

- Thermal test condition with vertical direction by natural convection (20LFM).

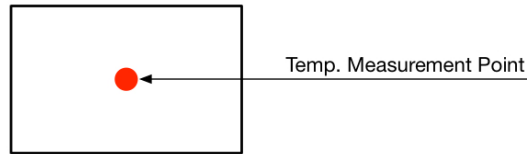

TOP VIEW

OUTPUT VOLTAGE ADJUSTMENT

It allows the user to increase or decrease the output voltage of the module. This is accomplished by connecting an external resistor between the Trim pin and either the +Vout or -Vout pins. With an external resistor between the Trim and -Output pin, the output voltage increases. With an external resistor between the Trim and +Output pin, the output voltage decreases. The external Trim resistor needs to be at least 1/10W of rated power.

Trim Up Equation

$$R_U = \left[\frac{G \times L}{(V_{o,up} - L - K)} - H \right] \Omega$$

Trim Down Equation

$$R_D = \left[\frac{(V_{o,down} - L) \times G}{(V_o - V_{o,down})} - H \right] \Omega$$

Trim constants

Module	G	H	K	L
RHK06-110S3P3W	5110	2050	0.8	2.5
RHK06-110S05W	5110	2050	2.5	2.5
RHK06-110S12W	10000	5110	9.5	2.5
RHK06-110S15W	10000	5110	12.5	2.5
RHK06-110S24W	56000	13000	21.5	2.5

Module	G	H	K	L
RHK06-110D05W	3000	3000	7.5	2.5
RHK06-110D12W	56000	13000	21.5	2.5
RHK06-110D15W	30000	13000	27.5	2.5

OUTPUT VOLTAGE ADJUSTMENT(CONTINUED)
EXTERNAL OUTPUT TRIMMING

Output can be externally trimmed by using the method shown below.

Trim-up

Single Output

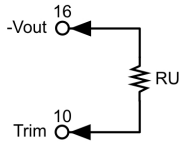

110S3P3W

ΔV (%)	1	2	3	4	5	6	7	8	9	10
Vout (V)	3.333	3.366	3.399	3.432	3.465	3.498	3.531	3.564	3.597	3.630
RU (k Ω)	385.071	191.511	126.990	94.730	75.374	62.470	53.253	46.340	40.963	36.662

110S05W

ΔV (%)	1	2	3	4	5	6	7	8	9	10
Vout (V)	5.050	5.100	5.150	5.200	5.250	5.300	5.350	5.400	5.450	5.500
RU (k Ω)	253.450	125.700	83.117	61.825	49.050	40.533	34.450	29.888	26.339	23.500

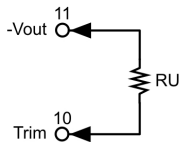
Dual Output

110S12W

ΔV (%)	1	2	3	4	5	6	7	8	9	10
Vout (V)	12.120	12.240	12.360	12.480	12.600	12.720	12.840	12.960	13.080	13.200
RU (k Ω)	203.223	99.057	64.334	46.973	36.557	29.612	24.652	20.932	18.038	15.723

110S15W

ΔV (%)	1	2	3	4	5	6	7	8	9	10
Vout (V)	15.150	15.300	15.450	15.600	15.750	15.900	16.050	16.200	16.350	16.500
RU (k Ω)	161.557	78.223	50.446	36.557	28.223	22.668	18.700	15.723	13.409	11.557

ΔV (%)	11	12	13	14	15	16	17	18	19	20
Vout (V)	16.650	16.800	16.950	17.100	17.250	17.400	17.550	17.700	17.850	18.000
RU (k Ω)	10.042	8.779	7.711	6.795	6.001	5.307	4.694	4.149	3.662	3.223

110S24W

ΔV (%)	1	2	3	4	5	6	7	8	9	10
Vout (V)	24.240	24.480	24.720	24.960	25.200	25.440	25.680	25.920	26.160	26.400
RU (k Ω)	570.333	278.667	181.444	132.833	103.667	84.222	70.333	59.917	51.815	45.333

ΔV (%)	11	12	13	14	15	16	17	18	19	20
Vout (V)	26.640	26.880	27.120	27.360	27.600	27.840	28.080	28.320	28.560	28.800
RU (k Ω)	40.030	35.611	31.872	28.667	25.889	23.458	21.314	19.407	17.702	16.167

110D05W

ΔV (%)	1	2	3	4	5	6	7	8	9	10
Vout (V)	± 5.050	± 5.100	± 5.150	± 5.200	± 5.250	± 5.300	± 5.350	± 5.400	± 5.450	± 5.500
RU (k Ω)	72.000	34.500	22.000	15.750	12.000	9.500	7.714	6.375	5.333	4.500

110D12W

ΔV (%)	1	2	3	4	5	6	7	8	9	10
Vout (V)	± 12.120	± 12.240	± 12.360	± 12.480	± 12.600	± 12.720	± 12.840	± 12.960	± 13.080	± 13.200
RU (k Ω)	570.333	278.667	181.444	132.833	103.667	84.222	70.333	59.917	51.815	45.333

110D15W

ΔV (%)	1	2	3	4	5	6	7	8	9	10
Vout (V)	± 15.150	± 15.300	± 15.450	± 15.600	± 15.750	± 15.900	± 16.050	± 16.200	± 16.350	± 16.500
RU (k Ω)	237.000	112.000	70.333	49.500	37.000	28.667	22.714	18.250	14.778	12.000

OUTPUT VOLTAGE ADJUSTMENT(CONTINUED)

Trim-down

Single & Dual Output

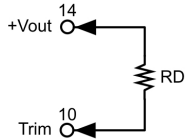

110S3P3W

ΔV (%)	1	2	3	4	5	6	7	8	9	10
Vout (V)	3.267	3.234	3.201	3.168	3.135	3.102	3.069	3.036	3.003	2.970
RD (k Ω)	116.719	54.779	34.133	23.810	17.616	13.486	10.537	8.325	6.604	5.228

110S05W

ΔV (%)	1	2	3	4	5	6	7	8	9	10
Vout (V)	4.950	4.900	4.850	4.800	4.750	4.700	4.650	4.600	4.550	4.500
RD (k Ω)	248.340	120.590	78.007	56.715	43.940	35.423	29.340	24.778	21.229	18.390

110S12W

ΔV (%)	1	2	3	4	5	6	7	8	9	10
Vout (V)	11.880	11.760	11.640	11.520	11.400	11.280	11.160	11.040	10.920	10.800
RD (k Ω)	776.557	380.723	248.779	182.807	143.223	116.834	97.985	83.848	72.853	64.057

110S15W

ΔV (%)	1	2	3	4	5	6	7	8	9	10
Vout (V)	14.850	14.700	14.550	14.400	14.250	14.100	13.950	13.800	13.650	13.500
RD (k Ω)	818.223	401.557	262.668	193.223	151.557	123.779	103.938	89.057	77.483	68.223

110S24W

ΔV (%)	1	2	3	4	5	6	7	8	9	10
Vout (V)	23.760	23.520	23.280	23.040	22.800	22.560	22.320	22.080	21.840	21.600
RD (k Ω)	4947.667	2439.333	1603.222	1185.167	934.333	767.111	647.667	558.083	488.407	432.667

110D05W

ΔV (%)	1	2	3	4	5	6	7	8	9	10
Vout (V)	± 4.950	± 4.900	± 4.850	± 4.800	± 4.750	± 4.700	± 4.650	± 4.600	± 4.550	± 4.500
RD (k Ω)	219.000	106.500	69.000	50.250	39.000	31.500	26.143	22.125	19.000	16.500

110D12W

ΔV (%)	1	2	3	4	5	6	7	8	9	10
Vout (V)	± 11.880	± 11.760	± 11.640	± 11.520	± 11.400	± 11.280	± 11.160	± 11.040	± 10.920	± 10.800
RD (k Ω)	4947.667	2439.333	1603.222	1185.167	934.333	767.111	647.667	558.083	488.407	432.667

110D15W

ΔV (%)	1	2	3	4	5	6	7	8	9	10
Vout (V)	± 14.850	± 14.700	± 14.550	± 14.400	± 14.250	± 14.100	± 13.950	± 13.800	± 13.650	± 13.500
RD (k Ω)	2707.000	1332.000	873.667	644.500	507.000	415.333	349.857	300.750	262.556	232.000