

30W isolated DC-DC converter
Ultra-wide input and regulated dual/single output

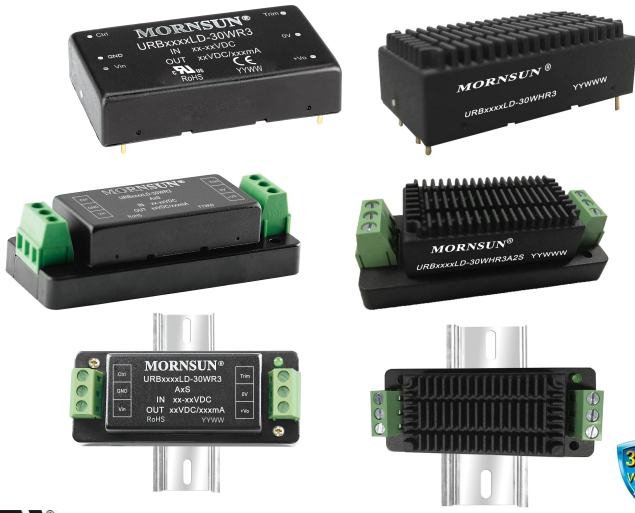

UL **CE** **CB Report** **Patent Protection** **RoHS**

UL60950-1 EN62368-1 IEC60950-1

URA_LD-30WR3 & URB_LD-30WR3 series of isolated 30W DC-DC converter products with an ultra-wide 4:1 input voltage and feature efficiencies of up to 90%. Input to output isolation is tested with 1500VDC and the converters safely operate ambient temperature of -40°C to +80°C, input under-voltage protection, output short-circuit, over-voltage, over-current protection. They meet CLASS A of CISPR32/EN55032 EMI standards without external components, optional packages are offered for chassis or DIN-rail mounting (A2S, A4S), adding additional input reverse polarity protection and they are widely used in applications such as data transmission device, battery power supply device, telecommunication device, distributed power supply system, hybrid module system, remote control system, industrial robot and railway fields.

FEATURES

- Ultra-wide 4:1 input voltage range
- High efficiency up to 90% with full load
- High efficiency up to 82% with 5% load
- No-load power consumption as low as 0.14W
- I/O isolation test voltage 1.5k VDC
- Input under-voltage protection, output short-circuit, over-voltage, over-current protection
- Operating ambient temperature range: -40°C to +80°C
- Meets CISPR32/EN55032 CLASS A without extra components
- Six-sided metal shielded package
- Input reverse polarity protection available with chassis(A2S) or Din-Rail mounting (A4S) version

Selection Guide

Certification	Part No. ①	Input Voltage (VDC)		Output		Full Load Efficiency ③ (%) Min./Typ.	Capacitive Load ④ (μF)Max.
		Nominal ② (Range)	Max. ③	Voltage (VDC)	Current (mA) Max./Min.		
UL/EN/IEC	URB2403LD-30WR3	24 (9-36)	40	3.3	6000/0	83/85	10000
	URB2405LD-30WR3			5	6000/0	84/86	10000
	URB2409LD-30WR3			9	3333/0	86/88	4700
	URB2412LD-30WR3			12	2500/0	88/90	2700
	URB2415LD-30WR3			15	2000/0	88/90	1680
	URB2424LD-30WR3			24	1250/0	88/90	680
EN	URA2405LD-30WR3			±5	±3000/0	84/86	2000
	URA2412LD-30WR3			±12	±1250/0	87/89	1250
	URA2415LD-30WR3			±15	±1000/0	87/89	680
	URA2424LD-30WR3			±24	±625/0	87/89	470
UL/EN/IEC	URB4803LD-30WR3	48 (18-75)	80	3.3	6000/0	84/86	10000
	URB4805LD-30WR3			5	6000/0	85/87	10000
	URB4812LD-30WR3			12	2500/0	86/88	2700
	URB4815LD-30WR3			15	2000/0	87/89	1680
	URB4824LD-30WR3			24	1250/0	85/87	680
EN	URA4805LD-30WR3			±5	±3000/0	84/86	2000
	URA4812LD-30WR3			±12	±1250/0	86/88	1250
	URA4815LD-30WR3			±15	±1000/0	86/88	680

Notes:
 ① Use "H" suffix for heat sink mounting, "A2S" suffix for chassis mounting and "A4S" suffix for DIN-Rail mounting. We recommend to choose modules with a heat sink for enhanced heat dissipation and applications with extreme temperature requirements;
 ② The minimum input voltage and starting voltage of A2S and A4S Model are 1VDC higher than those of DIP package due to input reverse polarity protection function;
 ③ Exceeding the maximum input voltage may cause permanent damage;
 ④ Efficiency is measured at nominal input voltage and rated output load; efficiencies for A2S and A4S Model's is decreased by 2% due to the input reverse

polarity protection circuit;

⑤The specified maximum capacitive load for positive and negative output is identical.

Input Specifications

Item	Operating Conditions	Min.	Typ.	Max.	Unit	
Input Current (full load / no-load)	24VDC nominal input series, nominal input voltage	3.3V output	--	971/60	994/100	mA
		5V output	--	1453/60	1488/100	
		Others	--	1420/6	1488/16	
	48VDC nominal input series, nominal input voltage	3.3V output	--	480/20	491/30	
		5V output	--	718/20	735/35	
		Others	--	710/5	744/10	
Reflected Ripple Current	Nominal input voltage	--	40	--		
Surge Voltage (1sec. max.)	24VDC nominal input series	-0.7	--	50	VDC	
	48VDC nominal input series	-0.7	--	100		
Start-up Voltage	24VDC nominal input series	--	--	9		
	48VDC nominal input series	--	--	18		
Input Under-voltage Protection	24VDC nominal input series	5.5	6.5	--		
	48VDC nominal input series	12.0	15.5	--		
Start-up Time	Nominal input voltage & constant resistance load	--	10	--	ms	
Input Filter		PI filter				
Hot Plug		Unavailable				
Ctrl *	Module on	Ctrl pin open or pulled high (3.5-12VDC)				
	Module off	Ctrl pin pulled low to GND (0-1.2VDC)				
	Input current when off	--	5	8	mA	

Note: *The Ctrl pin voltage is referenced to input GND.

Output Specifications

Item	Operating Conditions	Min.	Typ.	Max.	Unit	
Voltage Accuracy	5%-100% load	--	±1	±3		
	0%-5% load	--	±1	±5		
Linear Regulation	Input voltage variation from low to high at full load	Vo1	--	±0.2	±0.5	%
		Vo2	--	±0.5	±1	
Load Regulation ^①	5%-100% load	Vo1	--	±0.5	±1	
		Vo2	--	±0.5	±1.5	
Cross Regulation	Dual output, Vo1 load at 50%, Vo2 load at range of 10%-100%	--	--	±5		
Transient Recovery Time	25% load step change, nominal input voltage	--	300	500	μs	
Transient Response Deviation	25% load step change, nominal input voltage	3.3V/5V/±5V output	--	±5	±8	%
		Others	--	±3	±5	
Temperature Coefficient	Full load	--	--	±0.03	%/°C	
Ripple & Noise ^②	20MHz bandwidth, nominal input voltage, 100% load	Singe output	--	50	100	mVp-p
		Dual output	--	50	150	
Trim	Input voltage range	--	±10	--	%Vo	
Over-voltage Protection		110	--	160		
Over-current Protection		110	--	190	%Io	
Short-circuit Protection		Hiccup, continuous, self-recovery				

Note: ①Load regulation for 0%-100% load is ±5%;

②The "parallel cable" method is used for ripple and noise test, please refer to *DC-DC Converter Application Notes* for specific information.

General Specifications

Item	Operating Conditions	Min.	Typ.	Max.	Unit
Isolation	Input-output Electric Strength test for 1 minute with a leakage current of 1mA max.	1500	--	--	VDC
Insulation Resistance	Input-output resistance at 500VDC/60sec	1000	--	--	MΩ
Isolation Capacitance	Input-output capacitance at 100kHz/0.1V	--	2000	--	pF
Operating Temperature	See Fig. 1, Fig. 2, Fig. 3 and Fig. 4	-40	--	+80	°C
Storage Temperature		-55	--	+125	
Storage Humidity	Non-condensing	5	--	95	%RH
Pin Soldering Resistance Temperature	Soldering spot is 1.5mm away from case for 10 seconds	--	--	+300	°C
Vibration		IEC/EN61373 - Category 1, Grade B			
Switching Frequency *	PWM mode	--	300	--	kHz
MTBF	MIL-HDBK-217F@25°C	1000	--	--	k hours

Note:* Switching frequency is measured at full load. The module reduces the switching frequency for light load (below 50%) efficiency improvement.

Mechanical Specifications

Case Material	Aluminum alloy				
Dimensions	Horizontal package (without heat sink)		50.80 x 25.40 x 11.80 mm		
	Horizontal package (with heat sink)		51.40 x 26.20 x 16.50 mm		
	A2S chassis mounting (without heat sink)		76.00 x 31.50 x 21.20 mm		
	A2S chassis mounting (with heat sink)		76.00 x 31.50 x 25.30 mm		
	A4S Din-rail mounting (without heat sink)		76.00 x 31.50 x 25.80 mm		
	A4S Din-rail mounting (with heat sink)		76.00 x 31.50 x 29.90 mm		
Weight	Without heat sink	Horizontal package/A2S chassis mounting/A4S Din-rail mounting		27.8g/52.0g/72.0g(Typ.)	
	With heat sink	Horizontal package/A2S chassis mounting/A4S Din-rail mounting		37.0g/60.0g/80.0g(Typ.)	
Cooling Method	Free air convection				

Electromagnetic Compatibility (EMC)

Emissions	CE	Single output	CISPR32/EN55032	CLASS A (without external components)/ CLASS B (see Fig.6-② for recommended circuit)	
		Dual output	CISPR32/EN55032	CLASS A (without external components)/ CLASS B (see Fig.7-② for recommended circuit)	
	RE	Single output	CISPR32/EN55032	CLASS A (without external components)/ CLASS B (see Fig.6-② for recommended circuit)	
		Dual output	CISPR32/EN55032	CLASS A (without external components)/ CLASS B (see Fig.7-② for recommended circuit)	
Immunity	ESD		IEC/EN61000-4-2	Contact ±4kV	perf. Criteria B
	RS		IEC/EN61000-4-3	10V/m	perf. Criteria A
	EFT	Single output	IEC/EN61000-4-4	±2kV (see Fig.6-① for recommended circuit)	perf. Criteria B
		Dual output	IEC/EN61000-4-4	±2kV (see Fig.7-① for recommended circuit)	perf. Criteria B
	Surge	Single output	IEC/EN61000-4-5	line to line ±2kV (see Fig.6-① for recommended circuit)	perf. Criteria B
		Dual output	IEC/EN61000-4-5	line to line ±2kV (see Fig.7-① for recommended circuit)	perf. Criteria B
	CS	Single output	IEC/EN61000-4-6	3 Vr.m.s	perf. Criteria A
		Dual output	IEC/EN61000-4-6	10Vr.m.s	perf. Criteria A

Electromagnetic Compatibility (EMC) (EN50155)

Emissions	CE	Single output	EN50121-3-2 150kHz-500kHz	99dBμV (see Fig.6-② for recommended circuit)
		Dual output	EN5016-2-1 500kHz-30MHz	93dBμV (see Fig.6-② for recommended circuit)
Emissions	RE	Single output	EN50121-3-2 30MHz-230MHz	40dBμV/m at 10m (see Fig.6-② for recommended circuit)
		Single output	EN5016-2-1 230MHz-1GHz	47dBμV/m at 10m (see Fig.6-② for recommended circuit)

Emissions	RE	Dual output	EN50121-3-2 30MHz-230MHz EN55016-2-1 230MHz-1GHz	40dBµV/m at 10m (see Fig.7-② for recommended circuit) 47dBµV/m at 10m (see Fig.7-② for recommended circuit)
	ESD		EN50121-3-2	Contact ±6kV/Air ±8kV perf. Criteria A
Immunity	RS		EN50121-3-2	20V/m perf. Criteria A
	EFT	Single output	EN50121-3-2	±2kV 5/50ns 5kHz (see Fig.6-① for recommended circuit) perf. Criteria A
		Dual output	EN50121-3-2	±2kV 5/50ns 5kHz (see Fig.7-① for recommended circuit) perf. Criteria A
	Surge	Single output	EN50121-3-2	line to line ±1kV (42Ω, 0.5µF) (see Fig.6-① for recommended circuit) perf. Criteria A
		Dual output	EN50121-3-2	line to line ±1kV (42Ω, 0.5µF) (see Fig.7-① for recommended circuit) perf. Criteria A
	CS	Single output	EN50121-3-2	0.15MHz-80MHz 10V r.m.s perf. Criteria A
Dual output		EN50121-3-2	0.15MHz-80MHz 10V r.m.s perf. Criteria A	

Typical Characteristic Curves

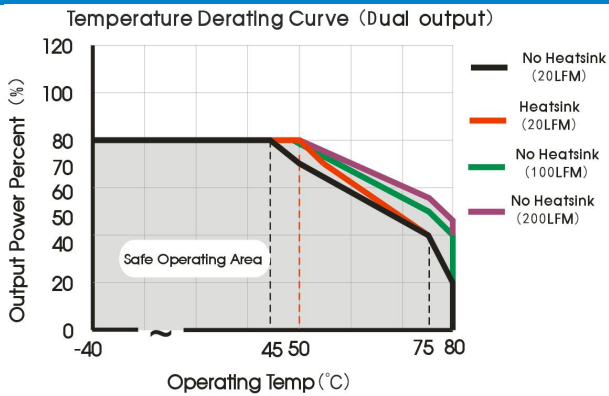

Fig. 1

Applicable models: URA2405LD-30W(H)R3 (9-18V input voltage), URA2424LD-30W(H)R3 (9-18V input voltage), URA4805LD-30W(H)R3 (18-36V input voltage)

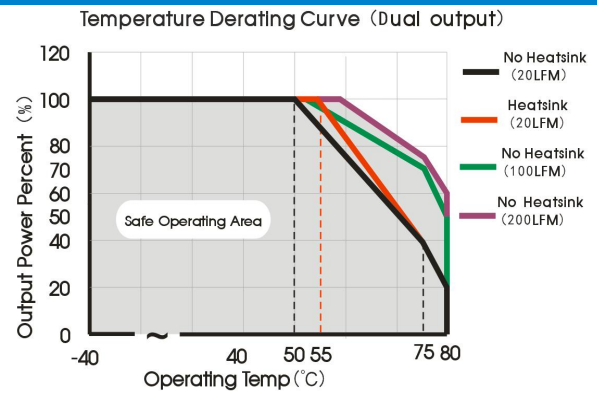

Fig. 2

Applicable models: URA2405LD-30W(H)R3 (18-36V input voltage), URA2424LD-30W(H)R3 (18-36V input voltage), URA4805LD-30W(H)R3 (36-75V input voltage), URA2412LD-30W(H)R3, URA2415LD-30W(H)R3, URA4812LD-30W(H)R3, URA4815LD-30W(H)R3

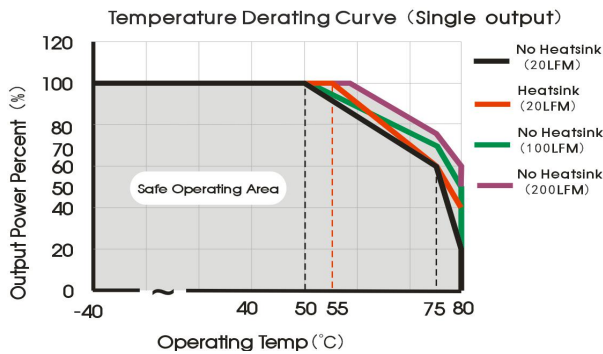

Fig. 3

Applicable models: URB2403LD-30W(H)R3, URB2405LD-30W(H)R3, URB4803LD-30W(H)R3, URB4805LD-30W(H)R3

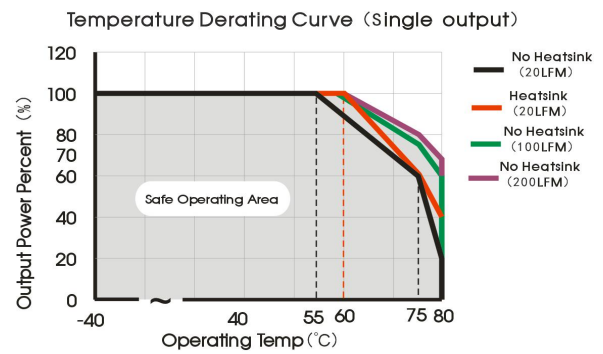
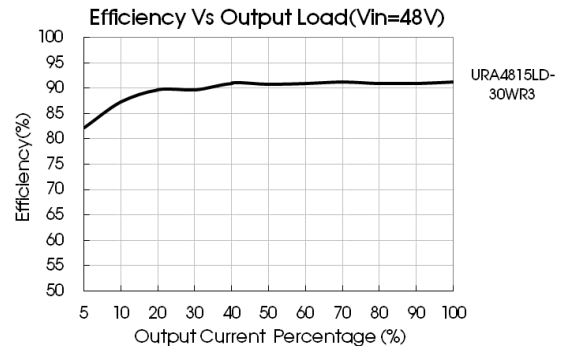
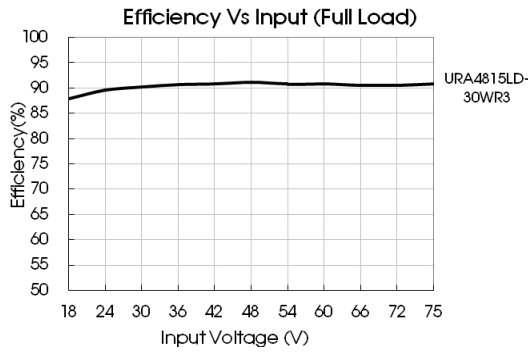
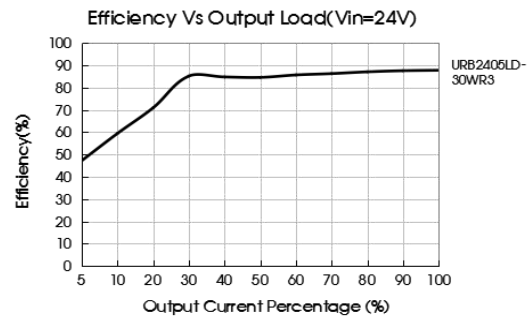
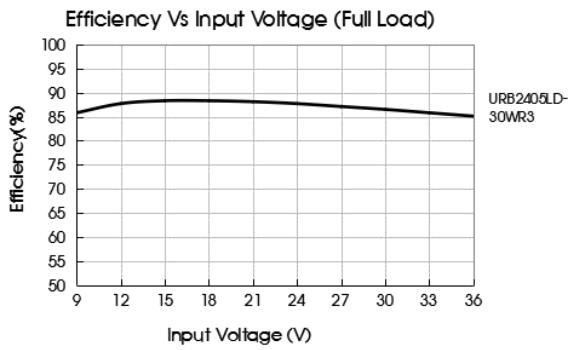

Fig. 4

Applicable models: URB2409LD-30W(H)R3, URB2412LD-30W(H)R3, URB2415LD-30W(H)R3, URB2424LD-30W(H)R3, URB4812LD-30W(H)R3, URB4815LD-30W(H)R3, URB4824LD-30W(H)R3



Design Reference

1. Typical application

All the DC/DC converters of this series are tested before delivery using the recommended circuit shown in Fig. 5.

Input and/or output ripple can be further reduced by appropriately increasing the input & output capacitor values C_{in} and C_{out} and/or by selecting capacitors with a low ESR (equivalent series resistance). Also make sure that the capacitance is not exceeding the specified max. capacitive load value of the product.

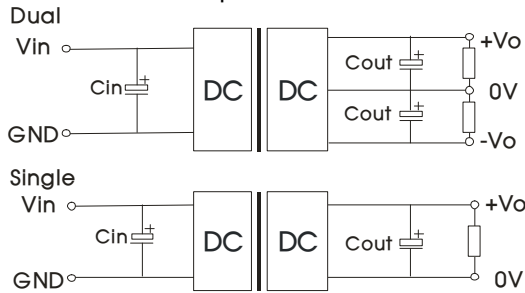

Fig. 5

Single output voltage (VDC)	C_{out} (μF)	C_{in} (μF)	Dual output voltage (VDC)	C_{out} (μF)	C_{in} (μF)
3.3/5/9	220	100	$\pm 5/\pm 12/\pm 15$	220	100
12/15/24	100		± 24	100	

2. EMC compliance circuit

Single output:

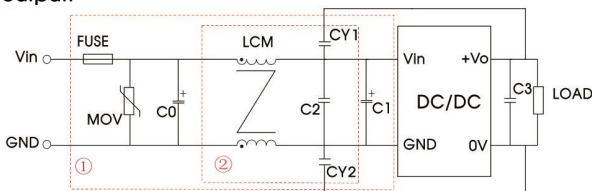

Fig. 6

Notes: We use Part ① in Fig. 6 for immunity and part ② for emissions test. Selecting based on needs.

Parameter description:

Model	Vin:24VDC	Vin:48VDC
FUSE	Choose according to actual input current	
MOV	S20K30	S14K60
C0	680 μF /50V	330 μF /100V
C1	330 μF /50V	330 μF /100V
C2	4.7 μF /50V	2.2 μF /100V
C3	Refer to the C_{out} in Fig.5	
LCM	1mH, recommended to use MORNSUN's FL2D-30-102	
CY1/CY2	1nF/2kV	

Dual output:

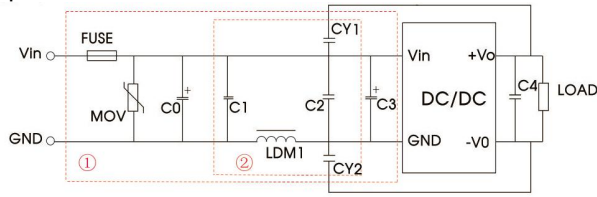
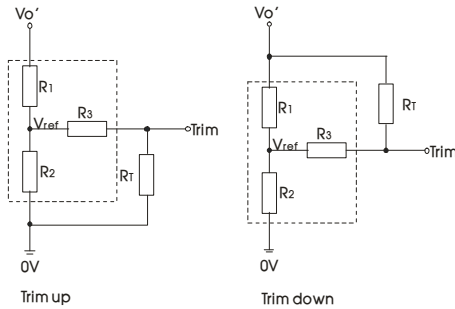

Fig.7

Notes: We use Part ① in Fig. 7 for immunity and part ② for emissions test.
Selecting based on needs.

Model	Vin:24VDC	Vin:48VDC
FUSE	Choose according to actual input current	
MOV	S20K30	S14K60
C0	680µF/50V	330µF/100V
C1/C2	2.2µF/50V	2.2µF/100V
C3	330µF/50V	330µF/100V
C4	Refer to the Cout in Fig.5	
LDM1	3.3µH	
CY1/CY2	2.2nF/400VAC Safety Y Capacitor	

3. Trim Function for Output Voltage Adjustment (open if unused)



Calculating Trim resistor values:

$$\text{up: } R_T = \frac{\alpha R_2}{R_2 - \alpha} - R_3 \quad \alpha = \frac{V_{ref}}{V_{o'} - V_{ref}} \cdot R_1$$

$$\text{down: } R_T = \frac{\alpha R_1}{R_1 - \alpha} - R_3 \quad \alpha = \frac{V_{o'} - V_{ref}}{V_{ref}} \cdot R_2$$

R_T = Trim Resistor value
 α = self-defined parameter
 $V_{o'}$ = desired output voltage

TRIM resistor connection (dashed line shows internal resistor network)

Vout(VDC)	R1(kΩ)	R2(kΩ)	R3(kΩ)	Vref(V)
3.3	4.801	2.87	12.4	1.24
5	2.883	2.87	10	2.5
9	7.500	2.87	15	2.5
12	11.000	2.87	15	2.5
15	14.494	2.87	15	2.5
24	24.872	2.87	17.8	2.5

4. The products do not support parallel connection of their output

5. For additional information please refer to DC-DC converter application notes on www.mornsun-power.com

Horizontal Package (without heat sink) Dimensions and Recommended Layout

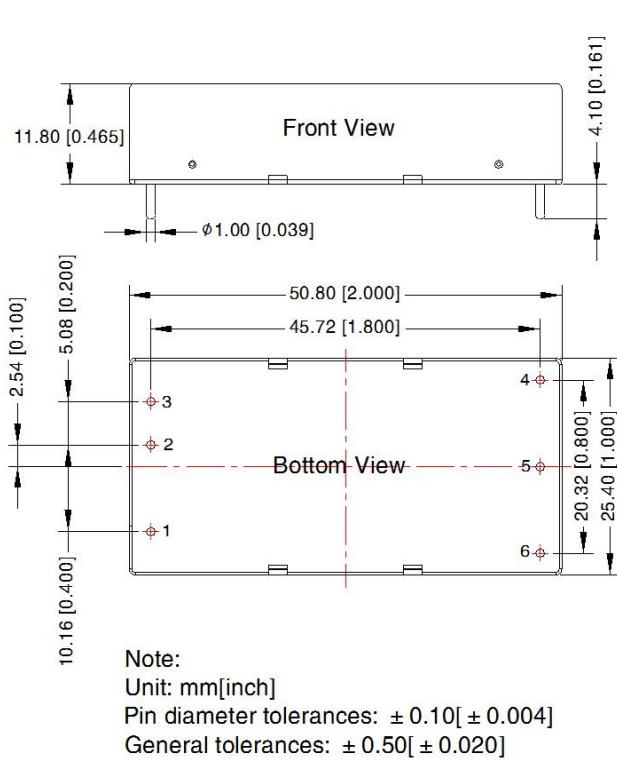

THIRD ANGLE PROJECTION

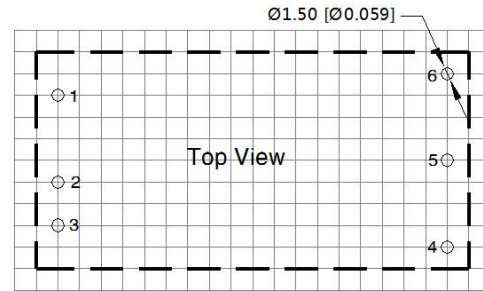

Pin-Out		
Pin	Single	Dual
1	Ctrl	Ctrl
2	GND	GND
3	Vin	Vin
4	+Vo	+Vo
5	0V	0V
6	Trim	-Vo

Horizontal Package (with heat sink) Dimensions

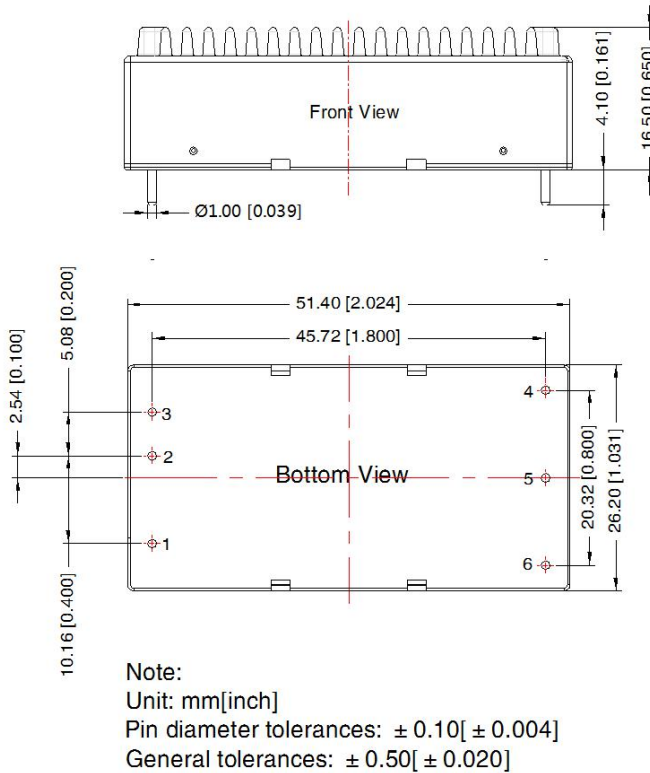

THIRD ANGLE PROJECTION

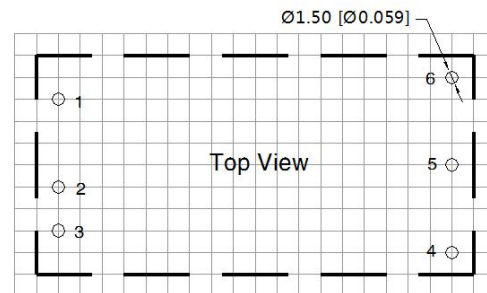

Pin-Out		
Pin	Single	Dual
1	Ctrl	Ctrl
2	GND	GND
3	Vin	Vin
4	+Vo	+Vo
5	0V	0V
6	Trim	-Vo

URA_LD-30WR3A2S & URB_LD-30WR3A2S(without heat sink) Dimensions

THIRD ANGLE PROJECTION

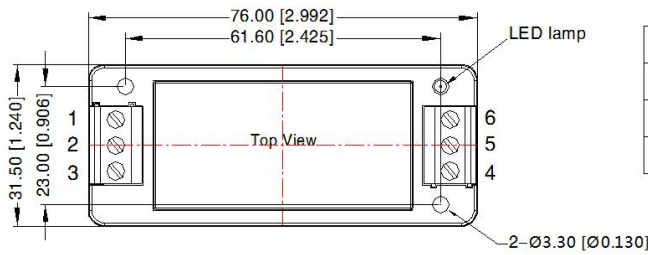

	Pin-Out					
Pin	1	2	3	4	5	6
Single	Ctrl	GND	Vin	+Vo	0V	Trim
Dual	Ctrl	GND	Vin	+Vo	0V	-Vo

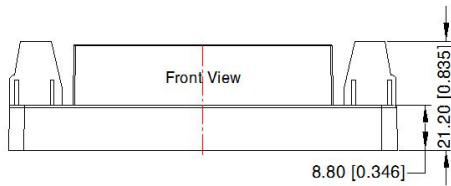

Note:
 Unit: mm[inch]
 Wire range: 24-12 AWG
 Tightening torque: Max 0.4 N·m
 General tolerances: ± 1.00 [± 0.039]

URA_LD-30WHR3A2S & URB_LD-30WHR3A2S(with heat sink) Dimensions

THIRD ANGLE PROJECTION

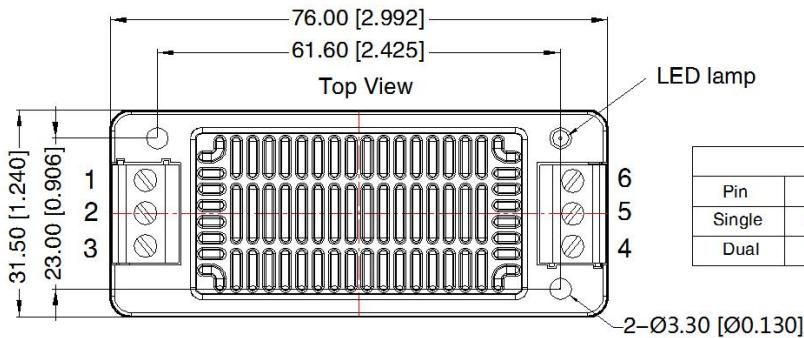

	Pin-Out					
Pin	1	2	3	4	5	6
Single	Ctrl	GND	Vin	+Vo	0V	Trim
Dual	Ctrl	GND	Vin	+Vo	0V	-Vo

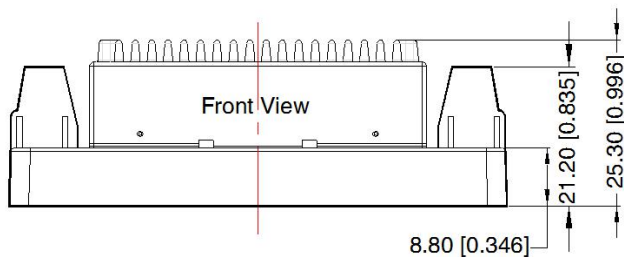

Note:
 Unit: mm[inch]
 Wire range: 24-12 AWG
 Tightening torque: Max 0.4 N · m
 General tolerances: ± 1.00 [± 0.039]

URA_LD-30WR3A4S & URB_LD-30WR3A4S(without heat sink) Dimensions

THIRD ANGLE PROJECTION 

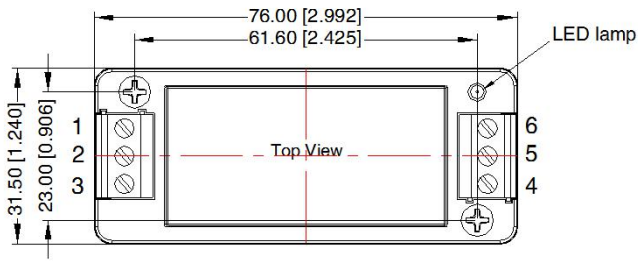

		Pin-Out					
Pin		1	2	3	4	5	6
Single		Ctrl	GND	Vin	+Vo	0V	Trim
Dual		Ctrl	GND	Vin	+Vo	0V	-Vo

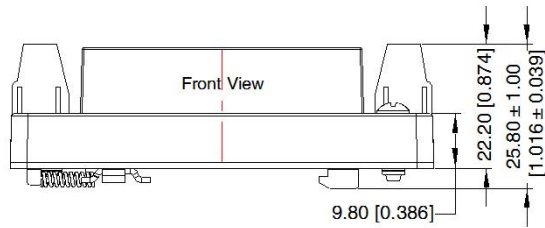

Note:
 Unit: mm[inch]
 Mounting rail: TS35
 Wire range: 24~12 AWG
 Tightening torque: Max 0.4 N·m
 General tolerances: ± 1.00 [± 0.039]

URA_LD-30WHR3A4S & URB_LD-30WHR3A4S(with heat sink) Dimensions

THIRD ANGLE PROJECTION 

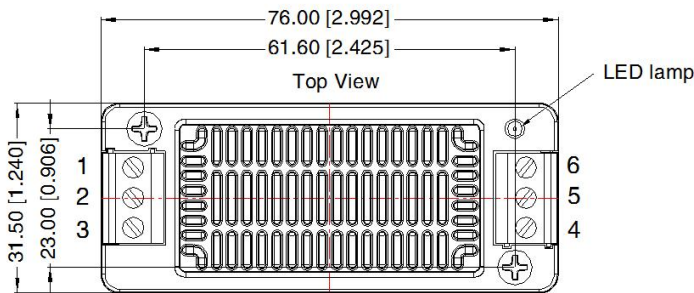

		Pin-Out					
Pin		1	2	3	4	5	6
Single		Ctrl	GND	Vin	+Vo	0V	Trim
Dual		Ctrl	GND	Vin	+Vo	0V	-Vo

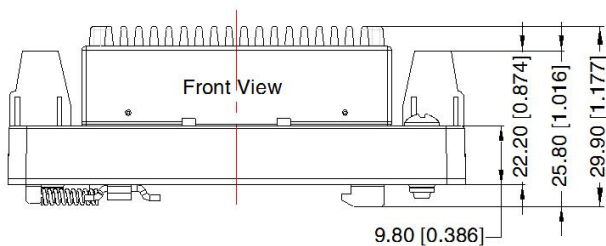

Note:
 Unit: mm[inch]
 Mounting rail: TS35
 Wire range: 24~12 AWG
 Tightening torque: Max 0.4 N·m
 General tolerances: ± 1.00 [± 0.039]

Notes:

1. For additional information on Product Packaging please refer to www.mornsun-power.com. Horizontal Packaging Bag Number: 58200035(without heat sink), 58200051(with heat sink), A2S/A4S Packaging Bag Number: 58220022;
2. The maximum capacitive load offered were tested at input voltage range and full load;
3. Unless otherwise specified, parameters in this datasheet were measured under the conditions of $T_a=25^{\circ}\text{C}$, humidity<75%RH with nominal input voltage and rated output load;
4. All index testing methods in this datasheet are based on company corporate standards;
5. We can provide product customization service, please contact our technicians directly for specific information;
6. Products are related to laws and regulations: see "Features" and "EMC";
7. Our products shall be classified according to ISO14001 and related environmental laws and regulations, and shall be handled by qualified units.

Mornsun Guangzhou Science & Technology Co., Ltd.

Address: No. 5, Kehui St. 1, Kehui Development Center, Science Ave., Guangzhou Science City, Huangpu District, Guangzhou, P. R. China
Tel: 86-20-38601850 Fax: 86-20-38601272 E-mail: info@mornsun.cn www.mornsun-power.com