

30W. Ultra wide Input Isolated & regulated dual/
single output. DC/DC converter



FEATURES

- Ultra wide input voltage range (4:1)
- High efficiency up to 90% with full load
- High efficiency up to 82% with 5% load
- No-load power consumption as low as 0.14W
- Isolation voltage: 1.5K VDC
- Input under-voltage protection, output short circuit, over-voltage, over-current protection
- Operating temperature range: -40°C to +80°C
- Meet CISPR32/EN55032 CLASS A, without external components
- Six-sided metal shielding package
- Reverse voltage protection available with A2S(Chassis mounting) or A4S(35mm DIN-Rail mounting)
- IEC60950, UL60950, EN60950 approval

UL US CE CB Patent Protection RoHS

URA_LD-30WR3 & URB_LD-30WR3 series are isolated 30W DC-DC products with 4:1 input voltage. They feature efficiency up to 90%, 1.5K VDC isolation, operating temperature of -40°C to +80°C. Input under-voltage protection, output short circuit protection, over-voltage protection, over-current protection and EMI meets CISPR32/EN55032 CLASS A, which make them widely applied in data transmission device, battery power supply device, tele-communication device, distributed power supply system, remote control system, industrial robot fields. And extension package A2S and A4S also enable them with reverse voltage protection.

Selection Guide

Certification	Part No.®	Input Voltage (VDC)		Output		Efficiency® (%Min./Typ.) ● Full Load	Max. Capacitive Load(µF)®
		Nominal® (Range)	Max.®	Output Voltage (VDC)	Output Current (mA)(Max./Min.)		
UL/CE/CB	URB2403LD-30WR3	24 (9-36)	40	3.3	6000/0	83/85	10000
	URB2405LD-30WR3			5	6000/0	86/88	10000
	URB2409LD-30WR3			9	3333/0	86/88	4700
	URB2412LD-30WR3			12	2500/0	88/90	2700
	URB2415LD-30WR3			15	2000/0	88/90	1680
	URB2424LD-30WR3			24	1250/0	88/90	680
CE	URA2405LD-30WR3			±5	±3000/0	84/86	2000
	URA2412LD-30WR3			±12	±1250/0	87/89	1250
	URA2415LD-30WR3			±15	±1000/0	87/89	680
	URA2424LD-30WR3			±24	±625/0	87/89	470
UL/CE/CB	URB4803LD-30WR3	48 (18-75)	80	3.3	6000/0	84/86	10000
	URB4805LD-30WR3			5	6000/0	86/88	10000
	URB4812LD-30WR3			12	2500/0	86/88	2700
	URB4815LD-30WR3			15	2000/0	87/89	1680
	URB4824LD-30WR3			24	1250/0	87/89	680
CE	URA4805LD-30WR3			±5	±3000/0	84/86	2000
	URA4812LD-30WR3			±12	±1250/0	86/88	1250
	URA4815LD-30WR3			±15	±1000/0	86/88	680

Notes: ①Series with suffix "H" are heat sink mounting; series with suffix "A2S" are chassis mounting, with suffix "A4S" are DIN-Rail mounting, for example URB2405LD-30WR3A2S is chassis mounting of with heat sink. URB2405LD-30WR3A4S is DIN-Rail mounting of without heat sink. If the application has a higher requirement for heat dissipation, you can choose modules with heat sink.
 ②A2S (wiring) and A4S (rail) Model due to input reverse polarity protection function, input voltage range the minimum value and starting voltage is higher than 1VDC DIP package.
 ③Absolute maximum rating without damage on the converter, but it isn't recommended.
 ④Efficiency is measured in nominal input voltage and rated output load. A2S (wiring) and A4S (rail) Model due to input reverse polarity protection, minimum efficiency greater than Min.-2 is qualified.
 ⑤ The capacitive loads of positive and negative outputs are identical.

Input Specifications

Item	Operating Conditions	Min.	Typ.	Max.	Unit	
Input Current (full load / no-load)	24VDC nominal input series, nominal input voltage	3.3V output	-	970/60	993/100	mA
		5V output	-	1420/60	1453/100	
		Others	-	1388/6	1488/12	
	48VDC nominal input series, nominal input voltage	3.3V output	-	474/20	485/30	
		5V output	-	710/20	726/35	
		Others	-	702/5	744/10	
Reflected Ripple Current	Nominal input voltage	-	40	-		
Surge Voltage (1sec. max.)	24VDC nominal input series	-0.7	-	50	VDC	
	48VDC nominal input series	-0.7	-	100		
Starting Voltage	24VDC nominal input series	-	-	9		
	48VDC nominal input series	-	-	18		
Shutdown Voltage	24VDC nominal input series	5.5	6.5	-		
	48VDC nominal input series	12.0	15.5	-		
Starting Time	Nominal input voltage & constant resistance load	-	10	-	ms	
Input Filter		PI filter				
Hot Plug		Unavailable				
Ctrl *	Module switch on	Ctrl suspended or connected to TTL high level (3.5-12VDC)				
	Module switch off	Ctrl pin connected to GND or low level (0-1.2VDC)				
	Input current when switched off	-	5	8	mA	

Note: *The voltage of Ctrl pin is relative to Input pin GND.

Output Specifications

Item	Operating Conditions	Min.	Typ.	Max.	Unit	
Output Voltage Accuracy	5%-100% load	-	±1	±3	%	
	0%-5% load	-	±1	±5		
Line Regulation	Full load, the input voltage is from low voltage to high voltage	Positive output	-	±0.2		±0.5
		Negative output	-	±0.5		±1
Load Regulation ^①	5%-100% load	Positive output	-	±0.5		±1
		Negative output	-	±0.5		±1.5
Cross Regulation	Dual output, main output 50% load, Supplement output from 10% - 100% load	-	-	±5		
Transient Recovery Time		-	300	500	μs	
Transient Response Deviation	25% load step change, nominal input voltage	3.3V/5V/±5V output	-	±5	±8	
		Others	-	±3	±5	
Temperature Coefficient	Full load	-	-	±0.03	%/°C	
Ripple & Noise ^②	20MHz bandwidth, nominal input voltage, 100% load	Single output	-	50	100	mV p-p
		Dual output	-	50	150	
Trim		-	±10	-	%Vo	
Output Over-voltage Protection		110	-	160		
Output Over-current Protection	Input voltage range	110	-	190		
Short circuit Protection		Hiccup, Continuous, self-recovery				

Note: ①When testing from 0% -100%load working conditions, load regulation index of ±5%.

②Ripple and noise are measured by "parallel cable" method, please see DC-DC Converter Application Notes for specific operation.

General Specifications

Item	Operating Conditions	Min.	Typ.	Max.	Unit
Insulation Voltage	Input-output, with the test time of 1 minute and the leak current lower than 1mA	1500	—	—	VDC
Insulation Resistance	Input-output, Insulation voltage 500VDC/60sec., T _a =25°C, humidity=75%RH	1000	—	—	MΩ
Isolation Capacitance	Input-output, 100KHz/0.1V	—	2000	—	pF
Operating Temperature	see Fig. 1, Fig. 2, Fig. 3 and Fig. 4	-40	—	+80	°C
Storage Temperature		-55	—	+125	
Storage Humidity	Non-condensing	5	—	95	%RH
Pin Welding Resistance Temperature	Welding spot is 1.5mm away from the casing, 10 seconds	—	—	+300	°C
Vibration		10-55Hz, 10G, 30 Min. along X, Y and Z			
Switching Frequency *	PWM mode	—	300	—	KHz
MTBF	MIL-HDBK-217F@25°C, Full load(Ground, Behign, controlled environment)	1000	—	—	K hours

Note: * This series of products using reduced frequency technology, the switching frequency is test value of full load. When the load is reduced to below 50%, the switching frequency decreases with decreasing load.

Physical Specifications

Casing Material	Aluminum alloy				
Package Dimensions	Horizontal package(without heat sink)		50.80*25.40*11.80 mm		
	Horizontal package(with heat sink)		51.40*26.20*16.50 mm		
	A2S wiring package (without heat sink)		76.00*31.50*21.20 mm		
	A2S wiring package(with heat sink)		76.00*31.50*25.30 mm		
	A4S rail package(without heat sink)		76.00*31.50*25.80 mm		
	A4S rail package(with heat sink)		76.00*31.50*29.90 mm		
Weight	without heat sink	Horizontal package/A2S wiring package/A4S rail package	26g/48g/68g(Typ.)		
	with heat sink	Horizontal package/A2S wiring package/A4S rail package	34g/56g/76g(Typ.)		
Cooling Method	Free air convection				

EMC Specifications

EMI	CE	Single output	CISPR32/EN55032	CLASS A (Bare component)/ CLASS B (see Fig.6-② for recommended circuit)	
		Dual output	CISPR32/EN55032	CLASS A (Bare component)/ CLASS B (see Fig.7-② for recommended circuit)	
	RE	Single output	CISPR32/EN55032	CLASS A (Bare component)/ CLASS B (see Fig.6-② for recommended circuit)	
		Dual output	CISPR32/EN55032	CLASS A (Bare component)/ CLASS B (see Fig.7-② for recommended circuit)	
EMS	ESD		IEC/EN61000-4-2	Contact ±4KV	perf. Criteria B
	RS		IEC/EN61000-4-3	10V/m	perf. Criteria A
	EFT	Single output	IEC/EN61000-4-4	±2KV (see Fig.6-① for recommended circuit)	perf. Criteria B
		Dual output	IEC/EN61000-4-4	±2KV (see Fig.7-① for recommended circuit)	perf. Criteria B
	Surge	Single output	IEC/EN61000-4-5	line to line ±2KV (see Fig.6-① for recommended circuit)	perf. Criteria B
		Dual output	IEC/EN61000-4-5	line to line ±2KV (see Fig.7-① for recommended circuit)	perf. Criteria B
	CS	Single output	IEC/EN61000-4-6	3 V _{trms}	perf. Criteria A
		Dual output	IEC/EN61000-4-6	10V _{trms}	perf. Criteria A

Product Characteristic Curve

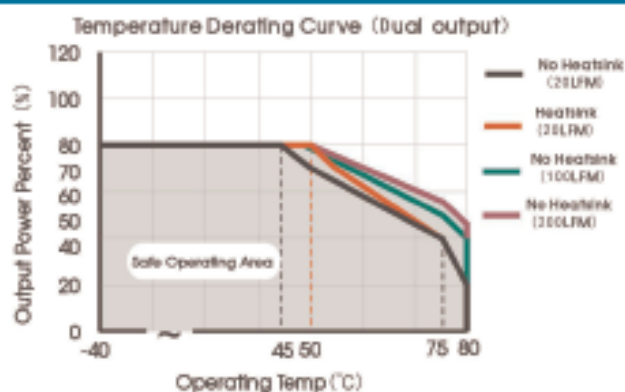

Fig. 1

Apply model: URA2405LD-30W(0)R3 (9-18V input voltage),
URA2424LD-30W(0)R3 (9-18V input voltage),
URA4805LD-30W(0)R3 (18-36V input voltage)

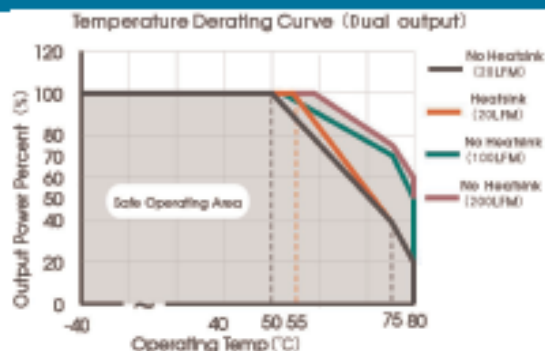

Fig. 2

Apply model: URA2405LD-30W(0)R3 (18-36V input voltage),
URA2424LD-30W(0)R3 (18-36V input voltage),
URA4805LD-30W(0)R3 (36-75V input voltage),
URA2412LD-30W(0)R3, URA2415LD-30W(0)R3,
URA4812LD-30W(0)R3, URA4815LD-30W(0)R3

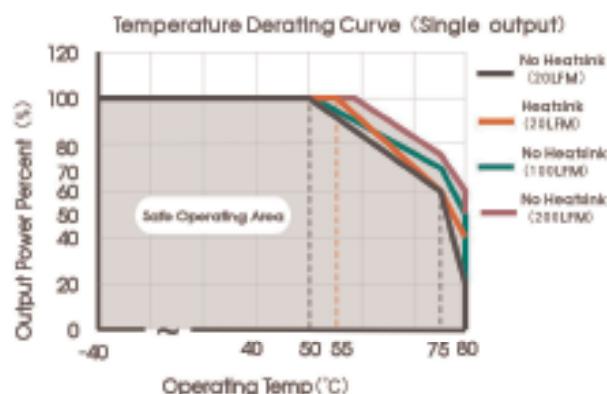

Fig. 3

Apply model: URB2403LD-30W(0)R3, URB2405LD-30W(0)R3,
URB4803LD-30W(0)R3, URB4805LD-30W(0)R3

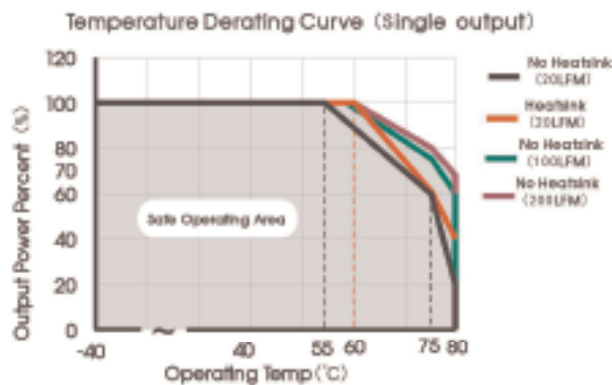
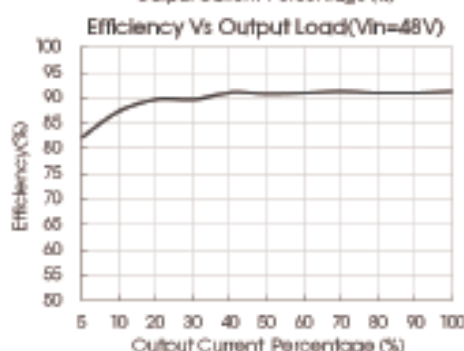
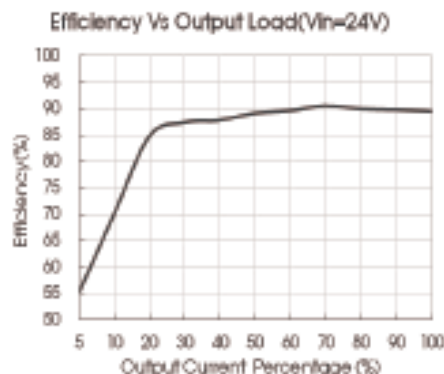
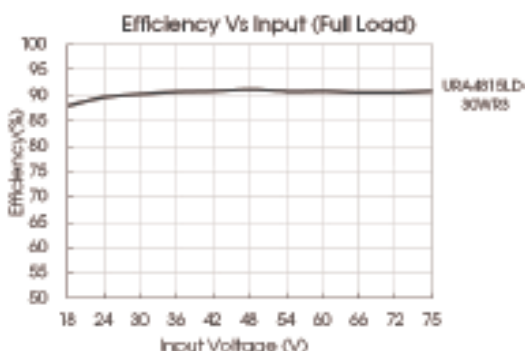
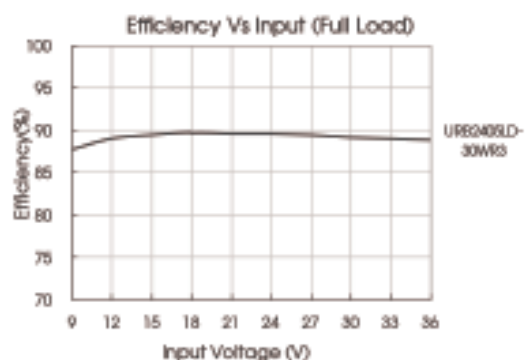

Fig. 4

Apply model: URB2409LD-30W(0)R3, URB2412LD-30W(0)R3,
URB2415LD-30W(0)R3, URB2424LD-30W(0)R3,
URB4812LD-30W(0)R3, URB4815LD-30W(0)R3,
URB4824LD-30W(0)R3



Design Reference

1. Typical application

All the DC/DC converters of this series are tested according to the recommended circuit (see Fig. 5) before delivery. If it is required to further reduce input and output ripple, properly increase the input & output of additional capacitors C_{in} and C_{out} or select capacitors of low equivalent impedance provided that the capacitance is no larger than the max. capacitive load of the product.

Dual output:



Single output:



Fig. 5

Single output voltage (VDC)	C _{out} (μF)	C _{in} (μF)	Dual output voltage (VDC)	C _{out} (μF)	C _{in} (μF)
3.3/5/9	220	100	±5/±12/±15	220	100
12/15/24	100		±24	100	

2. EMC solution-recommended circuit

Single output

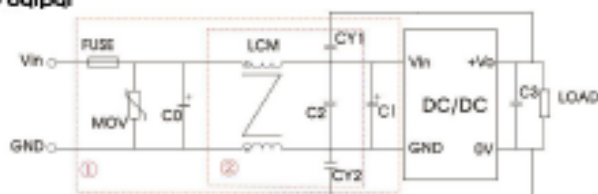

Fig. 6

Notes: Part ① in the Fig. 6 is used for EMC test and part ② for EMI filtering: selected based on needs.

Dual output

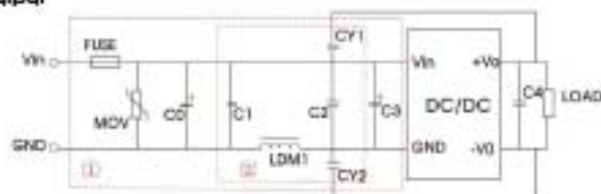

Fig. 7

Notes: Part ① in the Fig. 7 is used for EMC test and part ② for EMI filtering: selected based on needs.

Parameter description

Model	V _{in} :24V	V _{in} :48V
FUSE	Choose according to actual input current	
MOV	S20K30	S14K60
C0	680μF/50V	330μF/100V
C1	330μF/50V	330μF/100V
C2	4.7μF/50V	2.2μF/100V
C3	Refer to the C _{out} in Fig.5	
LCM	1mH, recommended to use MORNSUN's FL2D-30-102s	
CY1, CY2	1nF/2KV	

Model	V _{in} :24V	V _{in} :48V
FUSE	Choose according to actual input current	
MOV	S20K30	S14K60
C0	680μF/50V	330μF/100V
C1	2.2μF/50V	2.2μF/100V
C2	2.2μF/50V	2.2μF/100V
C3	330μF/50V	330μF/100V
C4	Refer to the C _{out} in Fig.5	
LDM1	3.3μH	
CY1, CY2	2.2nF/400VAC Safety Y Capacitor	

3. Application of Trim and calculation of Trim resistance

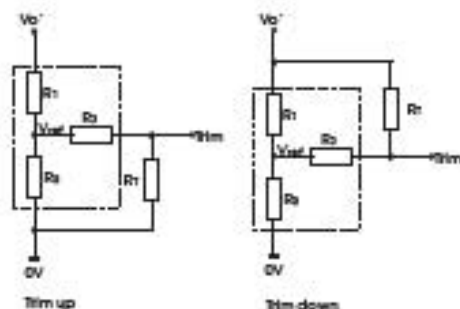

Applied circuits of Trim (Part in broken line is the interior of model)

Calculation formula of Trim resistance:

$$\begin{aligned} \text{up: } R_T &= \frac{\alpha R_2}{R_2 - \alpha} - R_3 & \alpha &= \frac{V_{ref}}{V_o' - V_{ref}} \cdot R_1 \\ \text{down: } R_T &= \frac{\alpha R_1}{R_1 - \alpha} - R_3 & \alpha &= \frac{V_o' - V_{ref}}{V_{ref}} \cdot R_2 \end{aligned}$$

R_T is Trim resistance. α is a self-defined parameter, with no real meaning. V_{o'} for the actual needs of the up or down regulated voltage

Vout(VDC)	R1(KΩ)	R2(KΩ)	R3(KΩ)	Vref(V)
3.3	4.801	2.87	12.4	1.24
5	2.883	2.87	10	2.5
9	7.500	2.87	15	2.5
12	11.000	2.87	15	2.5
15	14.494	2.87	15	2.5
24	24.872	2.87	17.8	2.5

- It is not allowed to connect modules output in parallel to enlarge the power
- For more information please find DC-DC converter application notes on www.mornsun-power.com

Horizontal Package (without heat sink) Dimensions and Recommended Layout

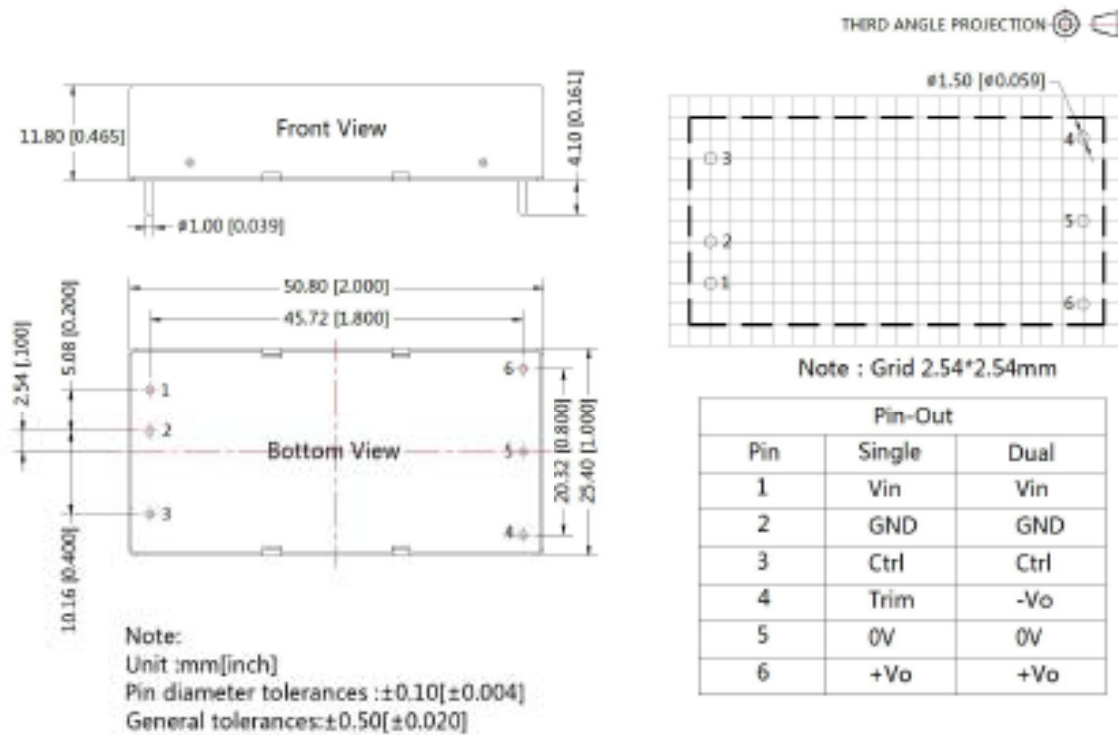

Horizontal Package (with heat sink) Dimensions

THIRD ANGLE PROJECTION

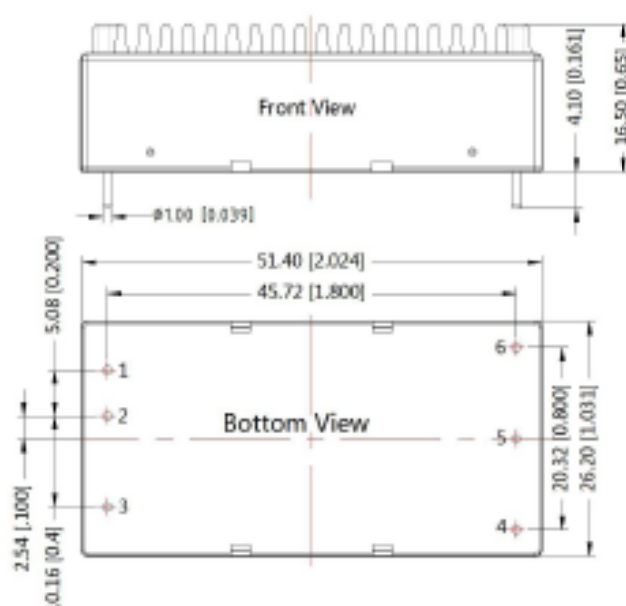

Pin-Out		
Pin	Single	Dual
1	Vin	Vin
2	GND	GND
3	Ctrl	Ctrl
4	Trim	-Vo
5	0V	0V
6	+Vo	+Vo

Note:
Unit: mm[inch]
General tolerances: ±0.50[±0.020]

URA_LD-30WR3A2S & URB_LD-30WR3A2S(without heat sink) Dimensions

THIRD ANGLE PROJECTION

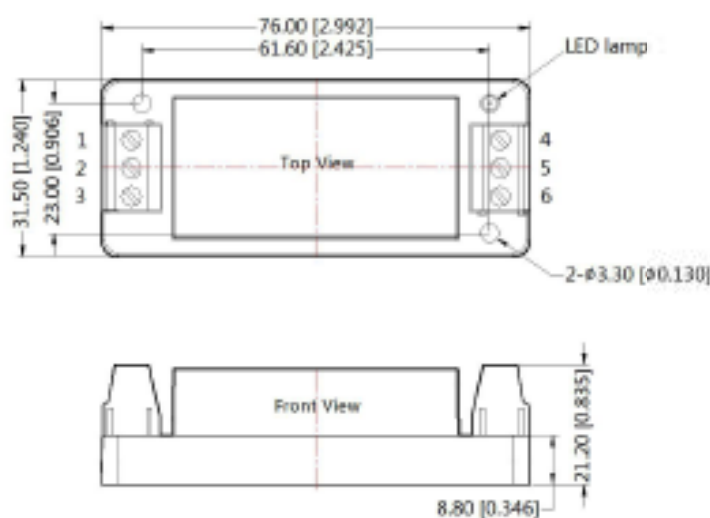

Pin-Out						
Pin	1	2	3	4	5	6
Single	Ctrl	GND	Vin	Trim	0V	+Vo
Dual	Ctrl	GND	Vin	-Vo	0V	+Vo

Note:
Unit: mm[inch]
Wire range: 24-12 AWG
Tightening torque: Max 0.4 N·m
General tolerances: ±0.50[±0.020]

URA_LD-30WR3A2S & URB_LD-30WR3A2S(with heat sink) Dimensions

THIRD ANGLE PROJECTION 

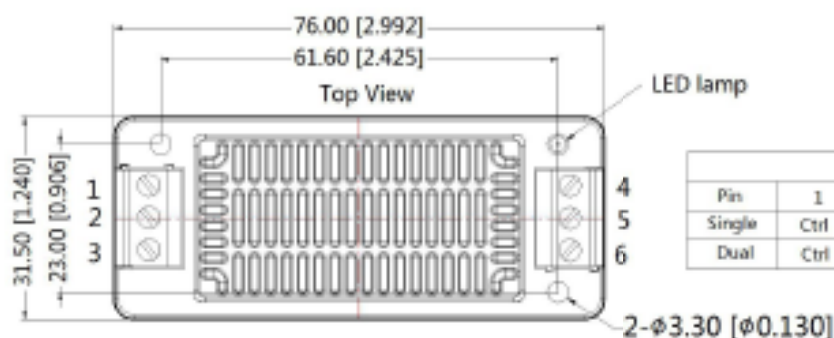

Pin-Out						
Pin	1	2	3	4	5	6
Single	Ctrl	GND	Vin	Trim	0V	+Vo
Dual	Ctrl	GND	Vin	-Vo	0V	+Vo

Note:
Unit: mm[inch]
Wire range: 24-12 AWG
Tightening torque: Max 0.4 N·m
General tolerances: ±0.50[±0.020]

URA_LD-30WR3A4S & URB_LD-30WR3A4S(without heat sink) Dimensions

THIRD ANGLE PROJECTION 

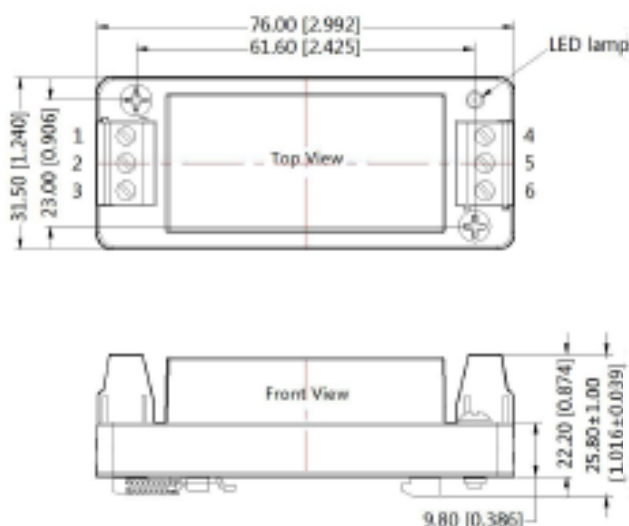

Pin-Out						
Pin	1	2	3	4	5	6
Single	Ctrl	GND	Vin	Trim	0V	+Vo
Dual	Ctrl	GND	Vin	-Vo	0V	+Vo

Note:
Unit: mm[inch]
Wire range: 24-12 AWG
Tightening torque: Max 0.4 N·m
General tolerances: ±0.50[±0.020]

URA_LD-30WR3A4S & URB_LD-30WR3A4S(with heat sink) Dimensions

THIRD ANGLE PROJECTION 

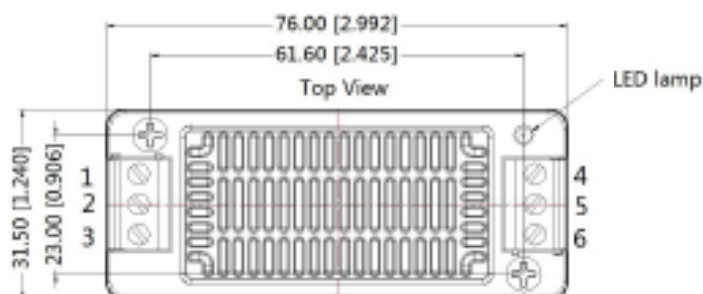

Pin-Out						
Pin	1	2	3	4	5	6
Single	Ctrl	GND	Vis	Trim	0V	+Vo
Dual	Ctrl	GND	Vis	-Vo	0V	+Vo

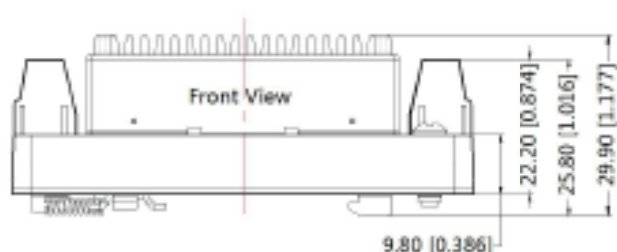

Note:
Unit: mm[inch]
Mounting rail: TS35
Wire range: 24-12 AWG
Tightening torque: Max 0.4 N·m
General tolerances: ±1.00[±0.039]

Notes:

1. Packing information please refer to Product Packing Information which can be downloaded from www.mornsun-power.com.
Horizontal Packing Bag Number: 58200035(without heat sink), 58200051(with heat sink), A2S/A4S Packing Bag Number: 58220022.
2. The maximum capacitive load offered were tested at input voltage range and full load.
3. Unless otherwise specified, parameters in this datasheet were measured under the conditions of $T_a=25^{\circ}\text{C}$, humidity<75%RH with nominal input voltage and rated output load.
4. All index testing methods in this datasheet are based on Company's corporate standards.
5. We can provide product customization service, please contact our technicians directly for specific information.
6. Products are related to laws and regulations: see "Features" and "EMC".
7. Our products shall be classified according to ISO14001 and related environmental laws and regulations, and shall be handled by qualified units.

Mornsun Guangzhou Science & Technology Co., Ltd.

Address: No. 5, Kehui St. 1, Kehui Development Center, Science Ave., Guangzhou Science City, Luogang District, Guangzhou, P. R. China
Tel: 86-20-38601850-8801 Fax: 86-20-38601272 E-mail: info@mornsun.cn